

13 Oct 2012

**ECCV Workshop on Parts and Attributes, Florence Italy**

# **The Cognitive Neuroscience of Object (Shape) Recognition**

**Irving Biederman**

*University of Southern California*

***Collaborators:***

**Ori Amir**

**Ken Hayworth**

**Mark Lescroart**

**Rufin Vogels**

**Moshe Bar**

***Sponsors:* AFOSR, NSF, Human Frontiers Foundation, NIMA, ARO, NVESD,  
NIH, McDonnell Foundation, Dornsife Foundation**

# Rapid Serial Visual Presentation (RSVP) Task

You will see a series of line drawings of common objects, each for 84 msec (70 msec on and 14 msec blank). This is 3 or 4 times faster than you can make voluntary eye movements (saccades). See if you can identify the objects as they fly by.

# RSVP DEMONSTRATION

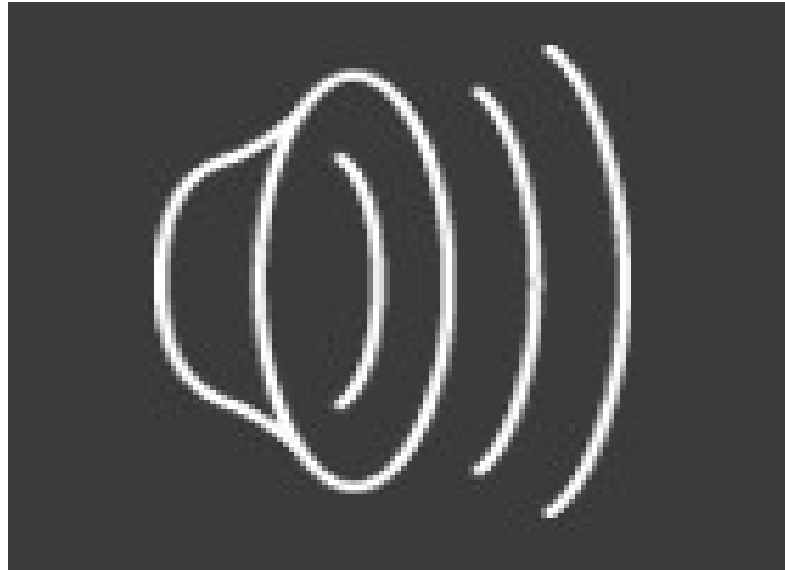

- 1. Detection. First get a subjective sense that you can identify the targets, then I will specify targets by name.**
- 2. Invariance of detection to noise**
- 3. Visual integration over 100 msec.**
- 4. Attentional “blink.” Detect the next object after a target.**
- 5. Is it fun?**

# Detecting Complex Scenes in 120 msec RSVP



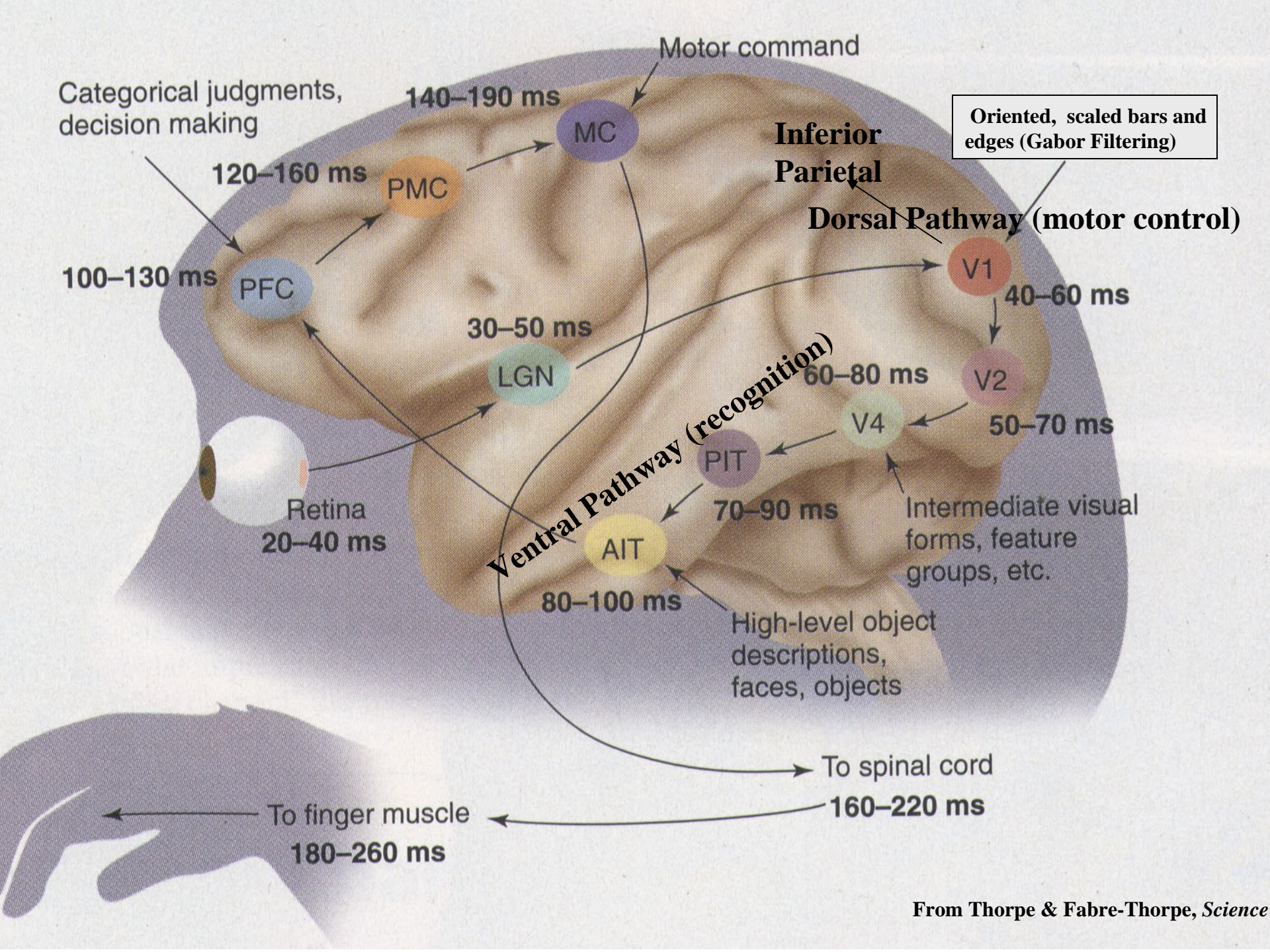

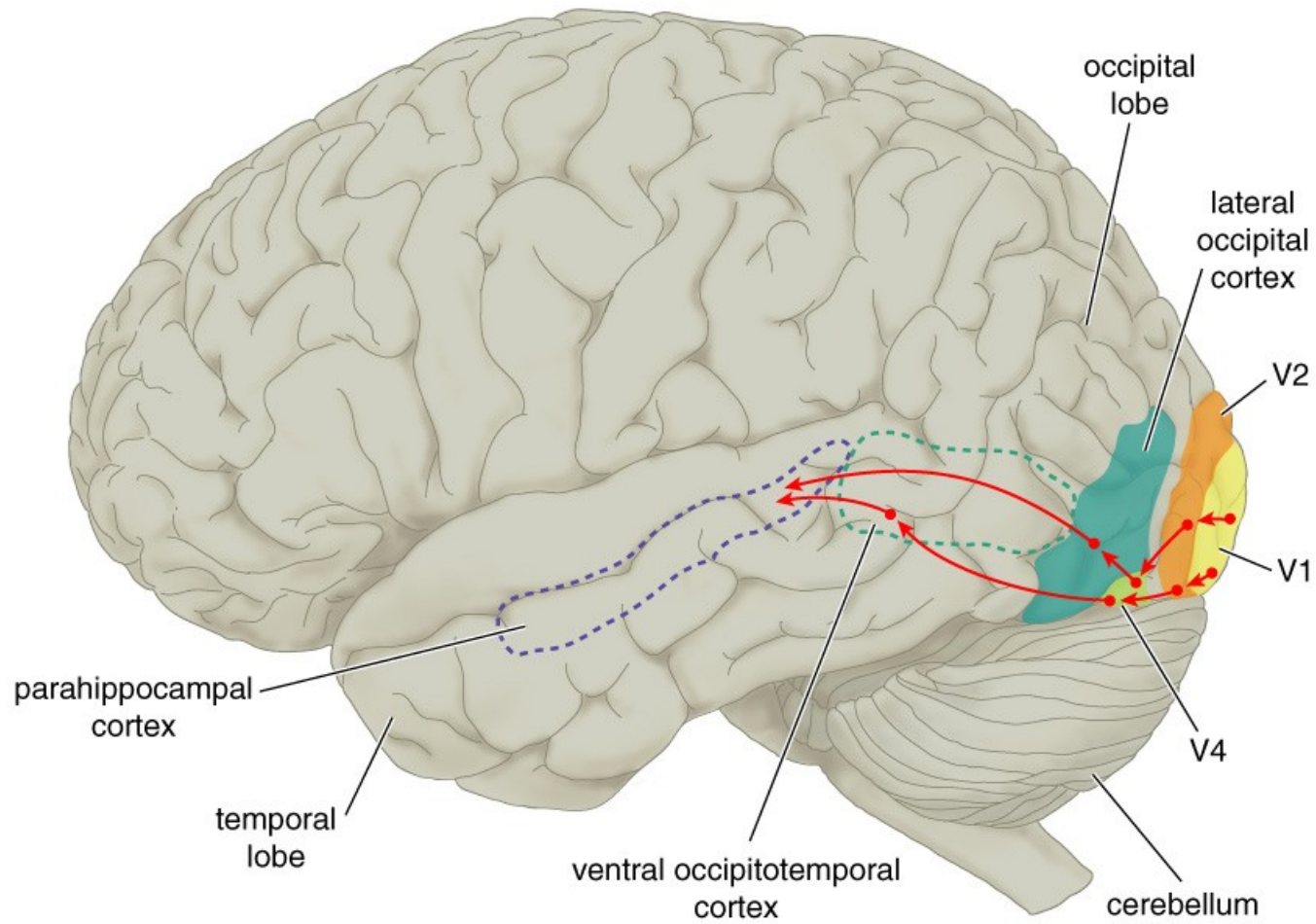

**Biederman & Vessel (2006) *American Scientist***

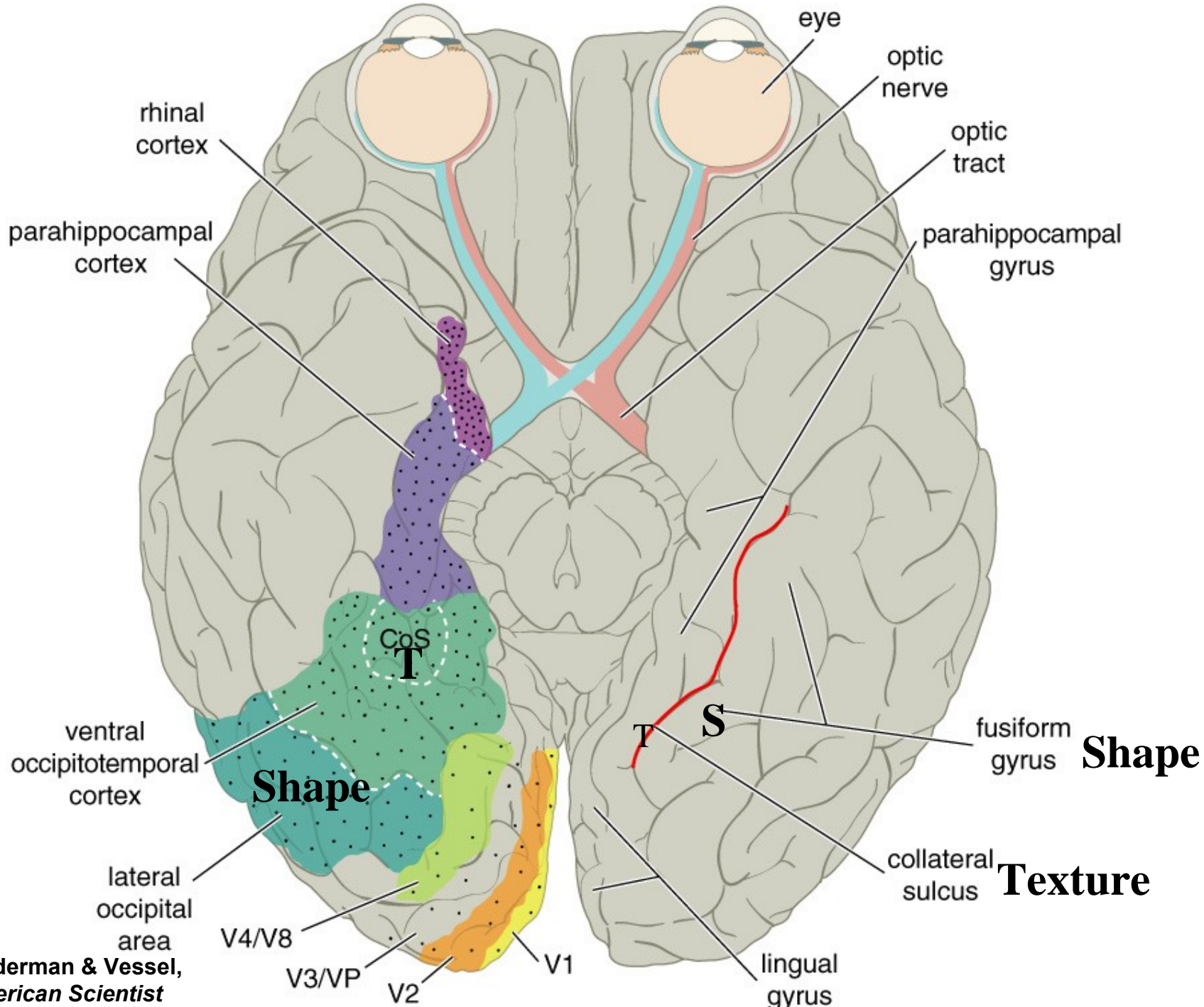

From Biederman & Vessel, 2006, *American Scientist*

# Localizing the Lateral Occipital Complex (LOC)

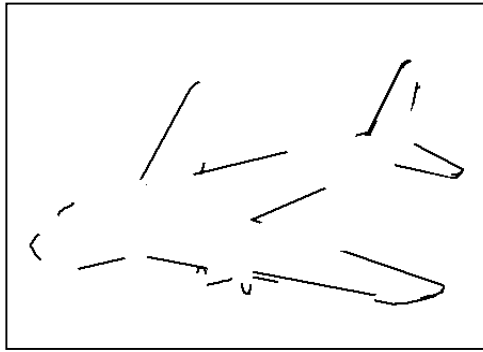

Scrambled

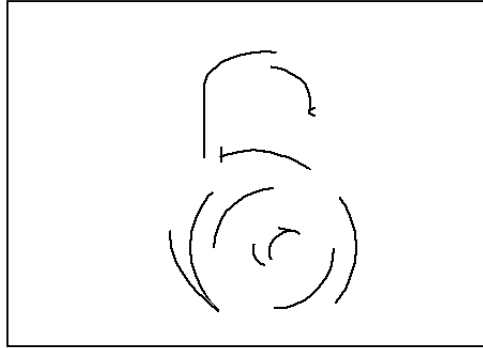
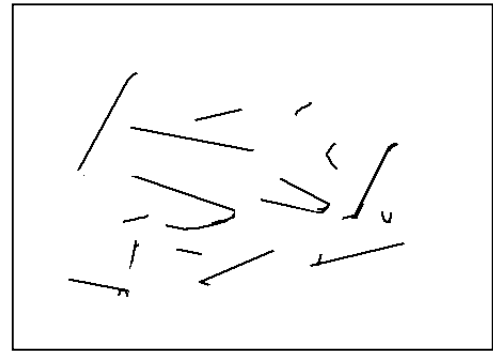
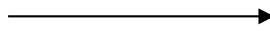

Scrambled

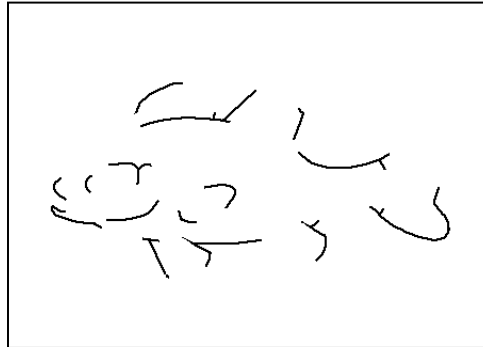
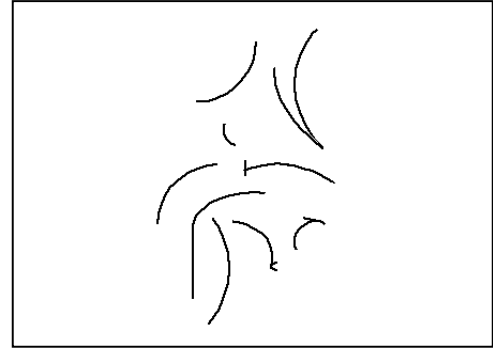
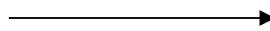

Scrambled

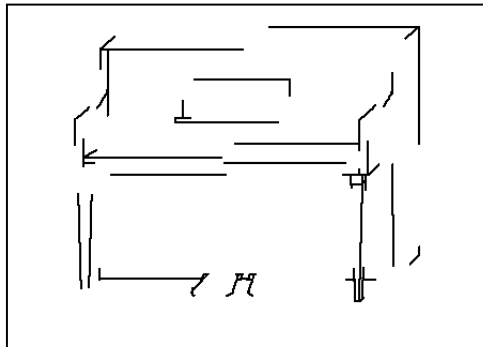
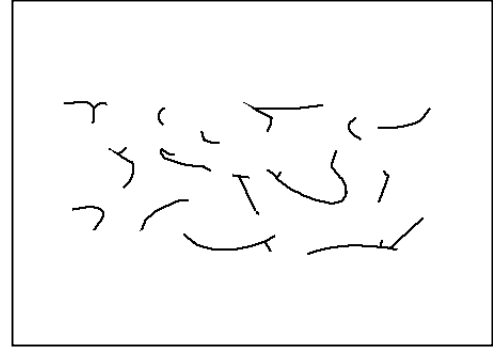
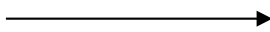

Scrambled

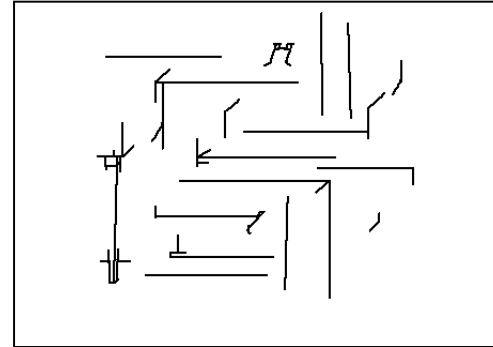
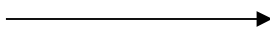



# Regions of Interest (**Intact minus Scrambled Objects**) Defined with Feature-Deleted LOC Localizer

(Hayworth & Biederman, 2006)

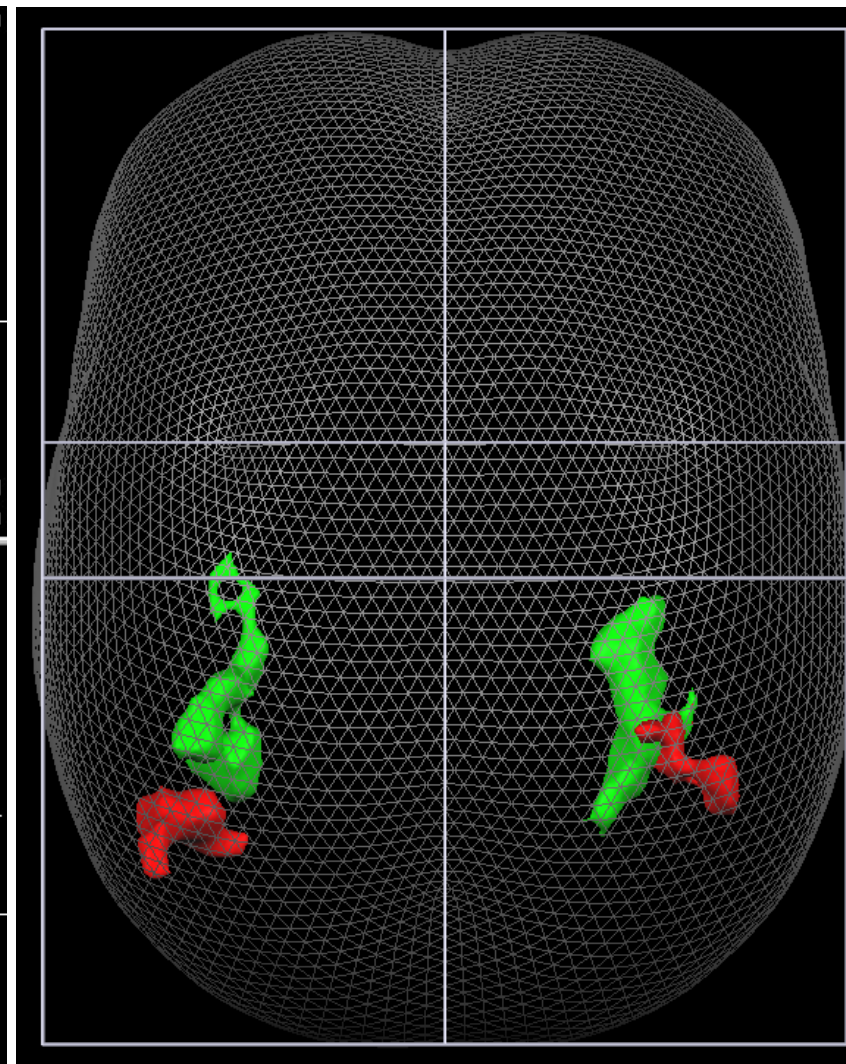
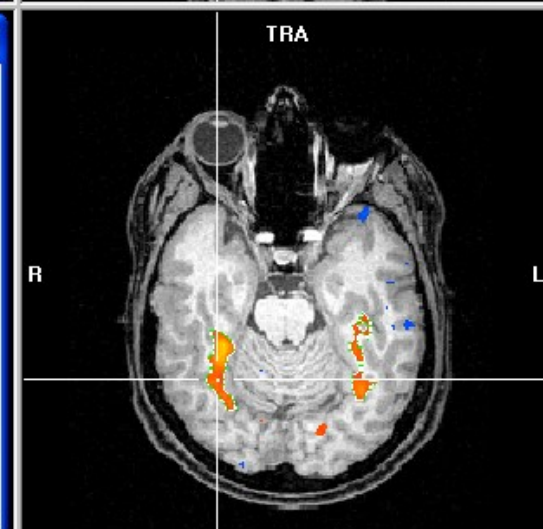
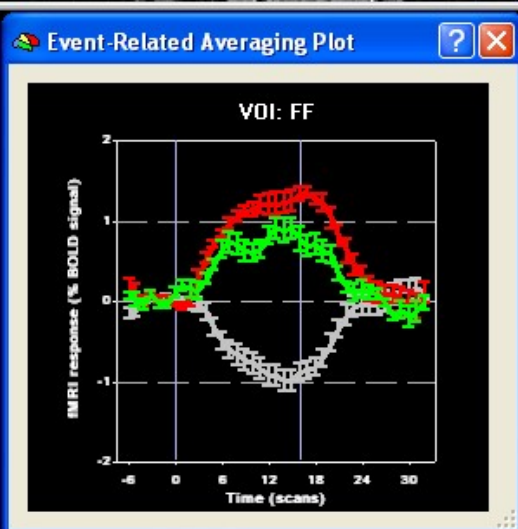
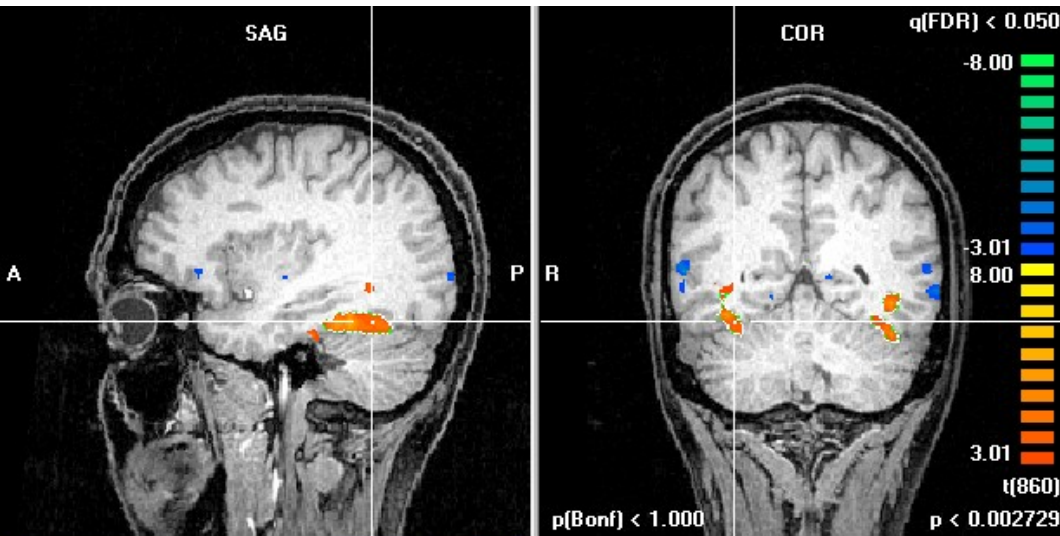

**D.F.: An individual with a lesion in expected location (upper row) of the lateral occipital complex (LOC) based on its location in controls (lower row)**

A. Lesions in Subject DF

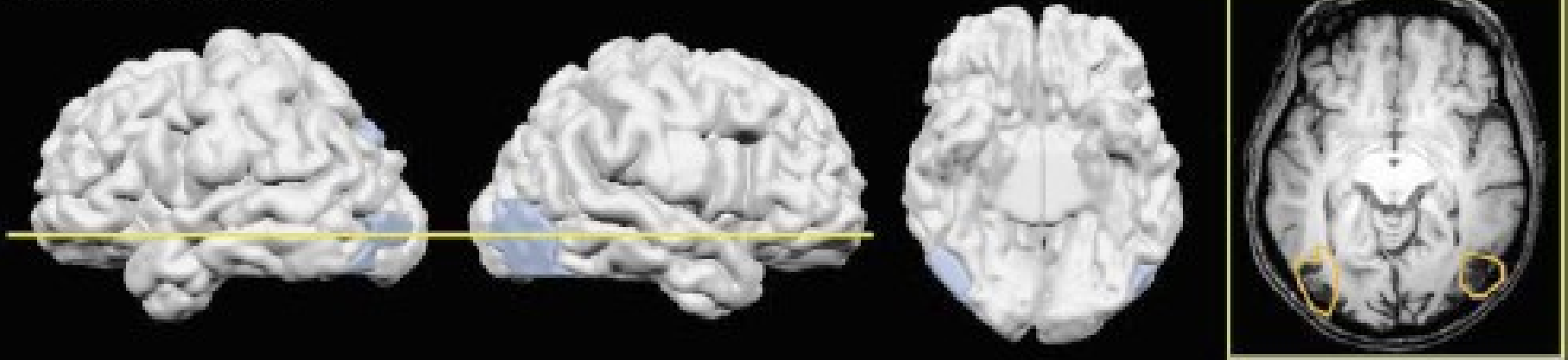

B. Location of LOC in Neurologically-Intact Subjects

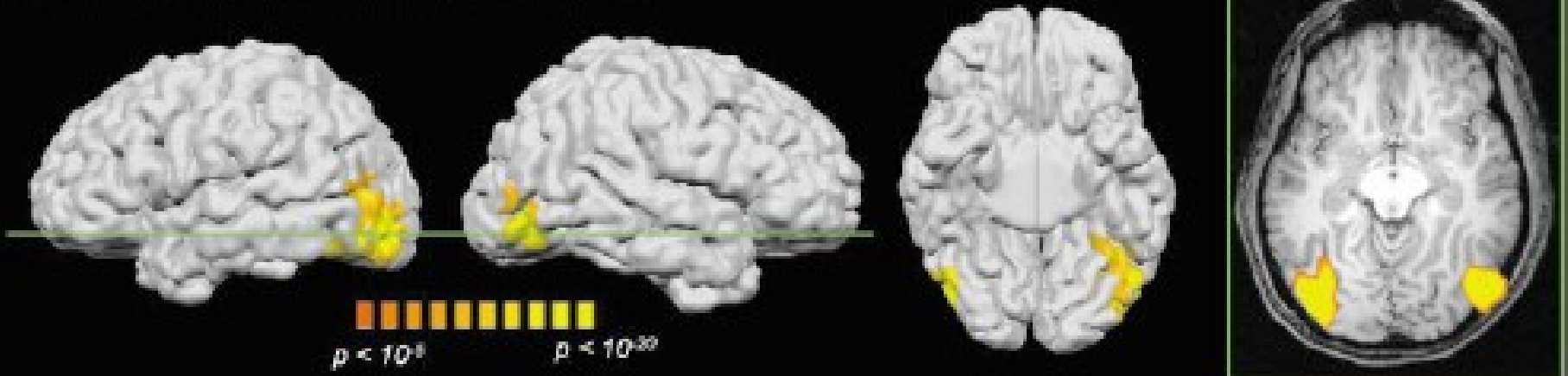

# Model



# Copy



# Memory

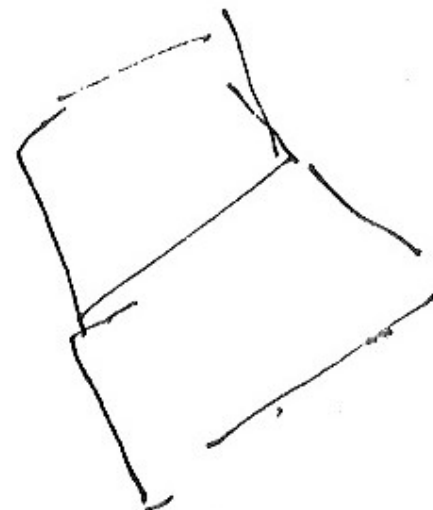
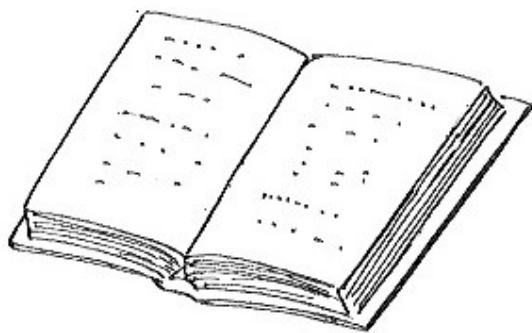
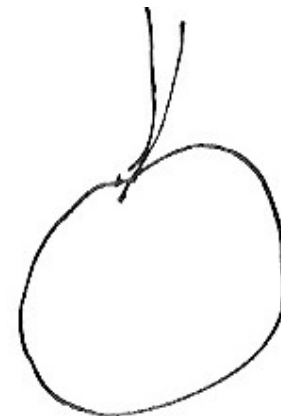



**“It’s made out of metal – is it aluminium?  
It’s got red plastic on it.”**

**“Is it some sort of kitchen utensil?”**

**RV**

**DF**

**Control**

**The geons differ  
in viewpoint  
invariant  
(nonaccidental)  
properties (NAPs  
).**

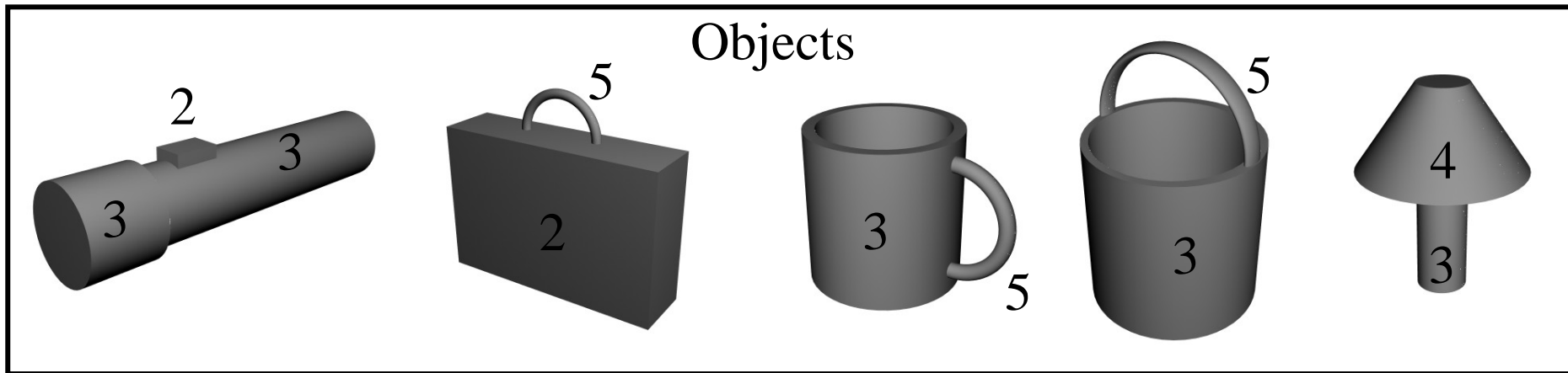
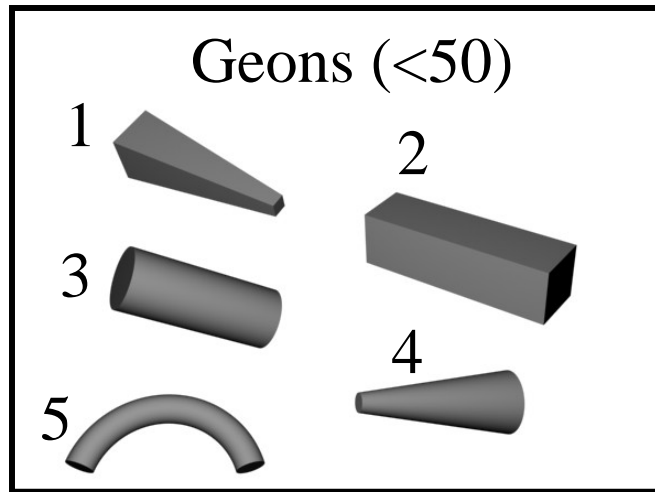

**With a small number of geon-pair relations (e.g., top-of; larger-than) several *billion* 2- or 3-part objects can be generated. Once 2 or 3 geons are recovered from an image, the basic- and often the subordinate-level classes of an object will almost always be identified.**

# EXAMPLES OF CONTRASTS (DIFFERENCES) IN NONACCIDENTAL PROPERTIES

## 1. SMOOTH CONTINUATION



## 2. COTERMINATION

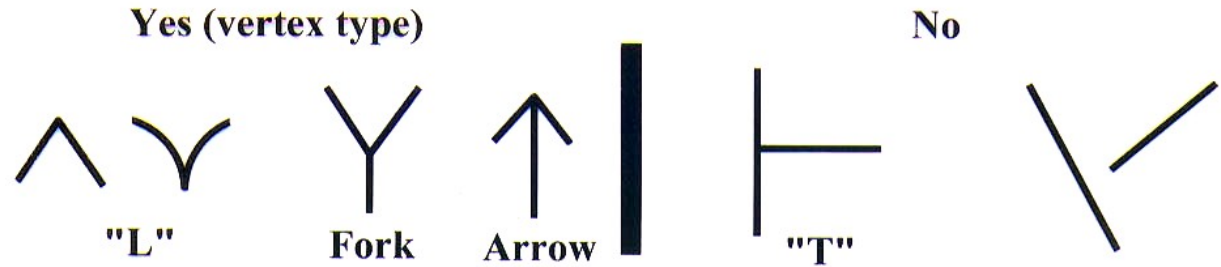

## 3. PARALLELISM and SYMMETRY

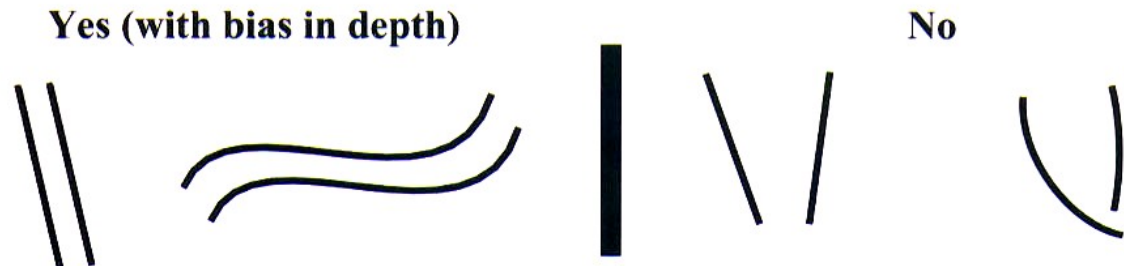

**NAPs provide strong evidence that a property in the image is true of the world and is not an accident of a particular viewpoint.**

**Fork and arrow vertices imply that the shape is volumetric (3D). L vertices signal the end of a surface.**

The set of geons is generated by variations in the production function for generalized cylinders that produce viewpoint-invariant (= nonaccidental) shape differences. These yield *simple* volumes (or shapes) with an axis of *symmetry*.

**Remarkably, there is strong evidence that the brain codes shapes in terms of these attributes!**

**1. Cross Section: Straight vs. Curved**



**2. Axis: Straight vs. Curved**



**3. Size of Cross Section: Constant (parallel sides) vs. Expand vs. Expand & Contract vs Contract & Expand**

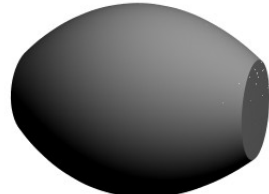
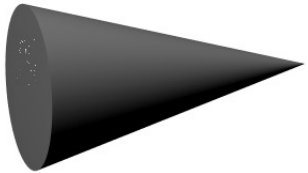

**4. Termination of Geon when Nonparallel: Truncated vs. Pointed vs. Rounded**





# Why symmetry?

**Parts have U-shaped structures; that is, they go out and come back (Rao, 1990).**

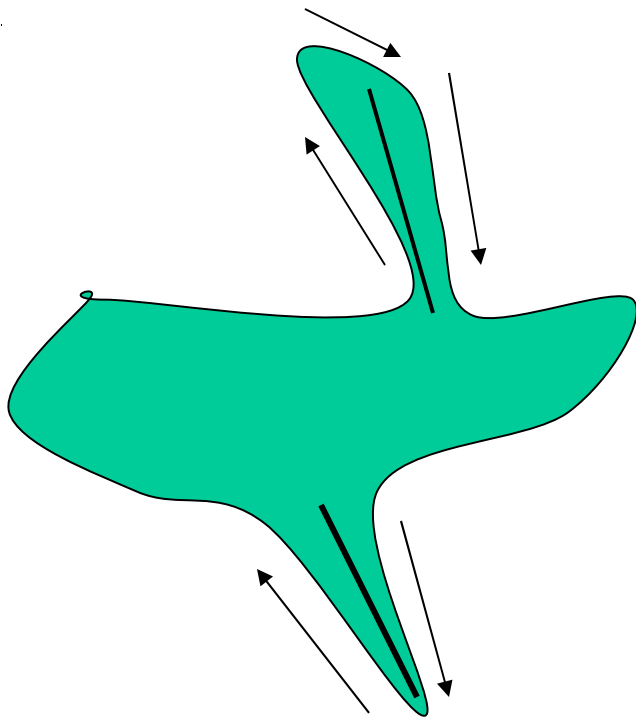

**Approximate axes of symmetry can be fitted to each of these U-shapes.**

# Some Nonaccidental Differences Between a Brick and a Cylinder that Can be Conveyed by a Line Drawing

**Brick**

**Cylinder**

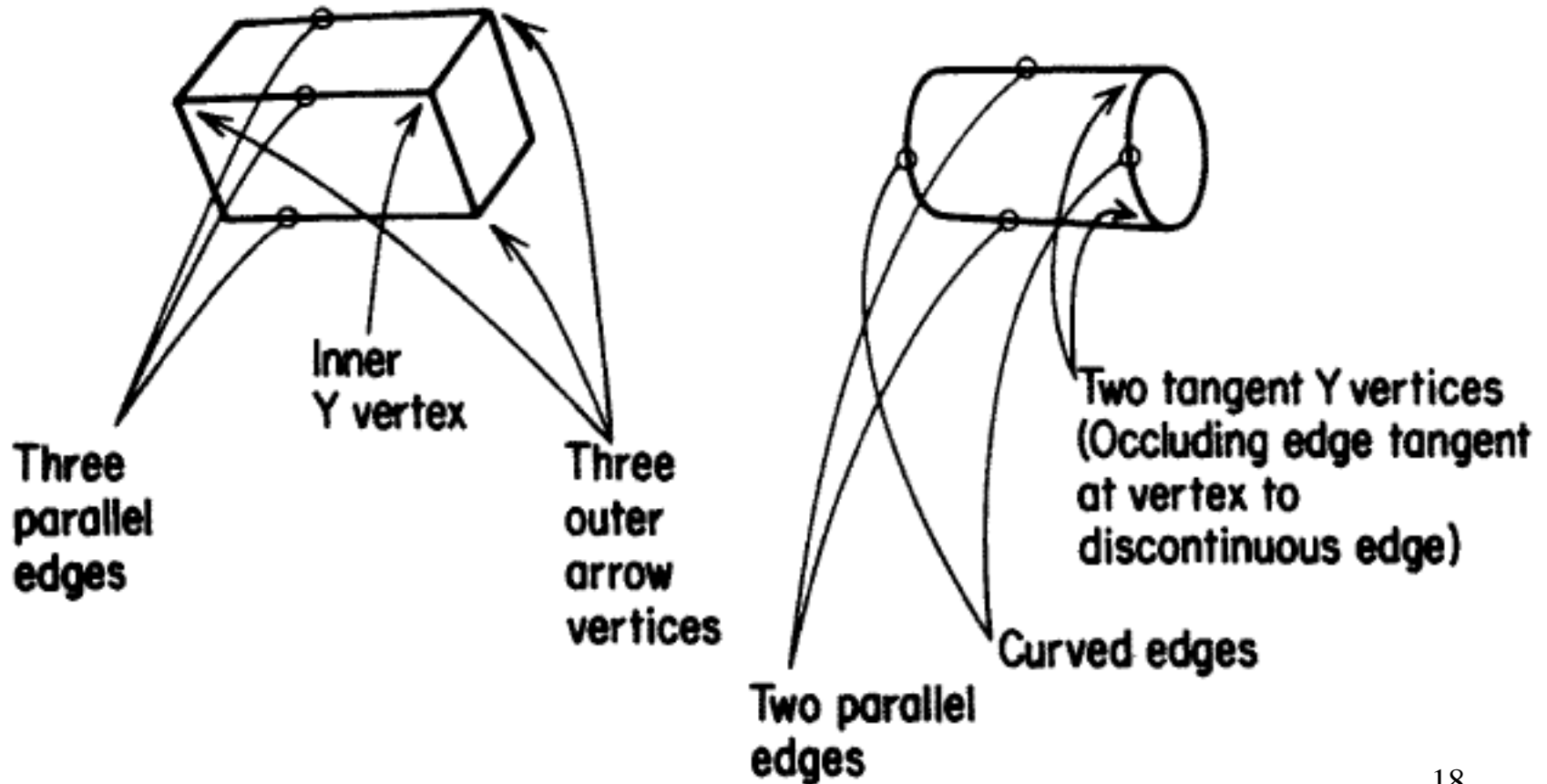

# Orientation and Depth Discontinuities

## Orientation Discontinuities

## Depth Discontinuities

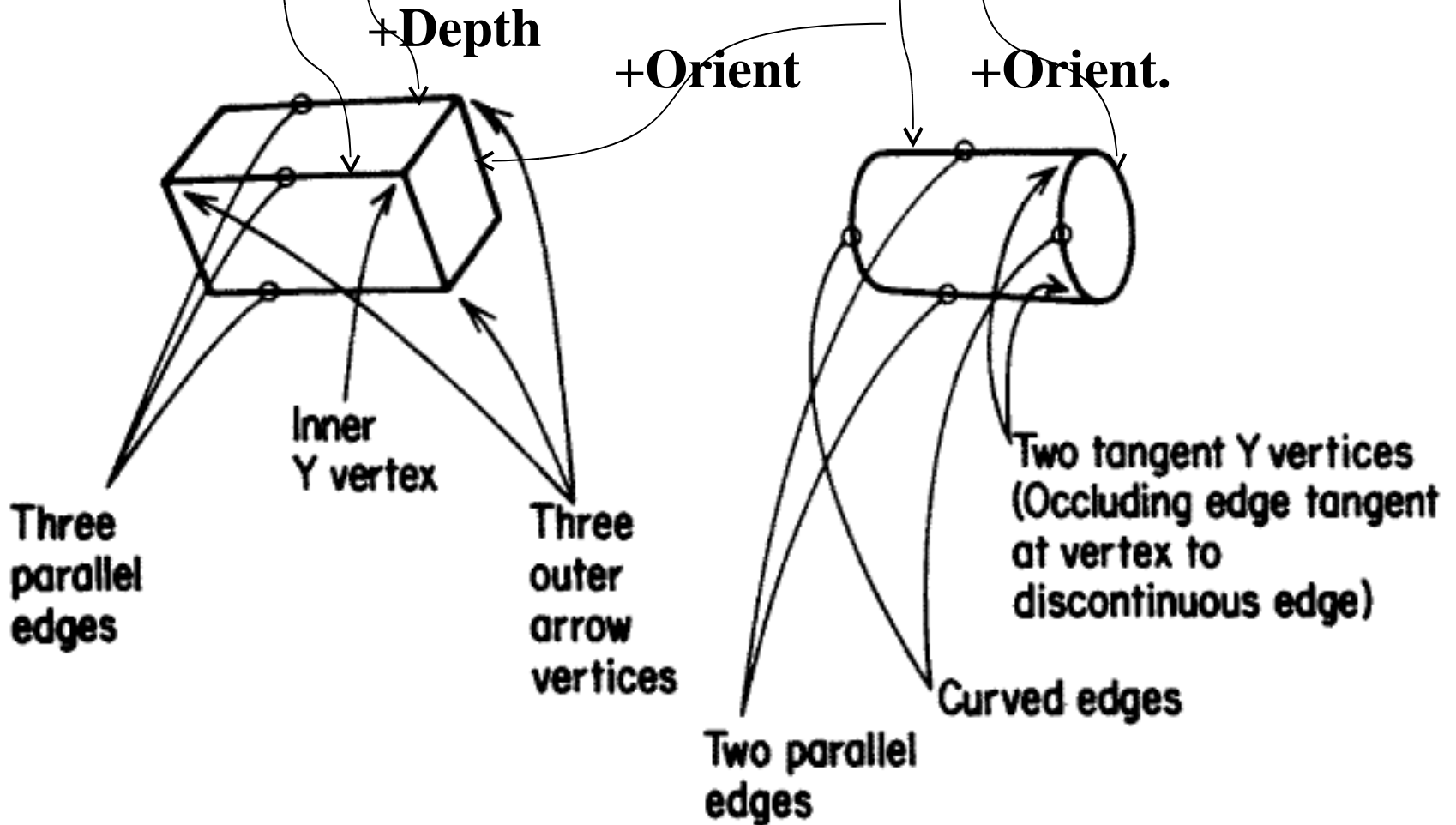

**Two or three parts are almost always sufficient.**

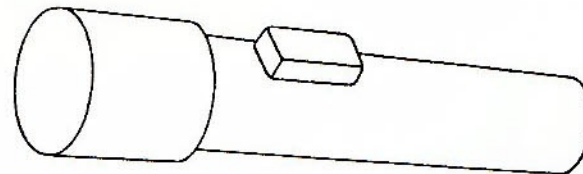
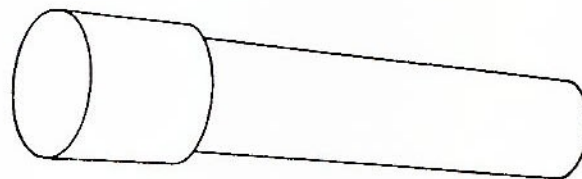
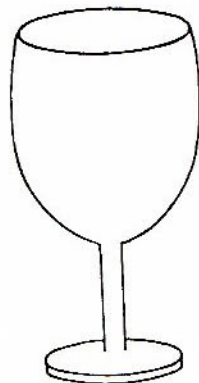
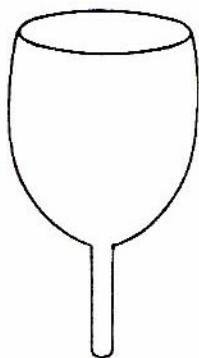
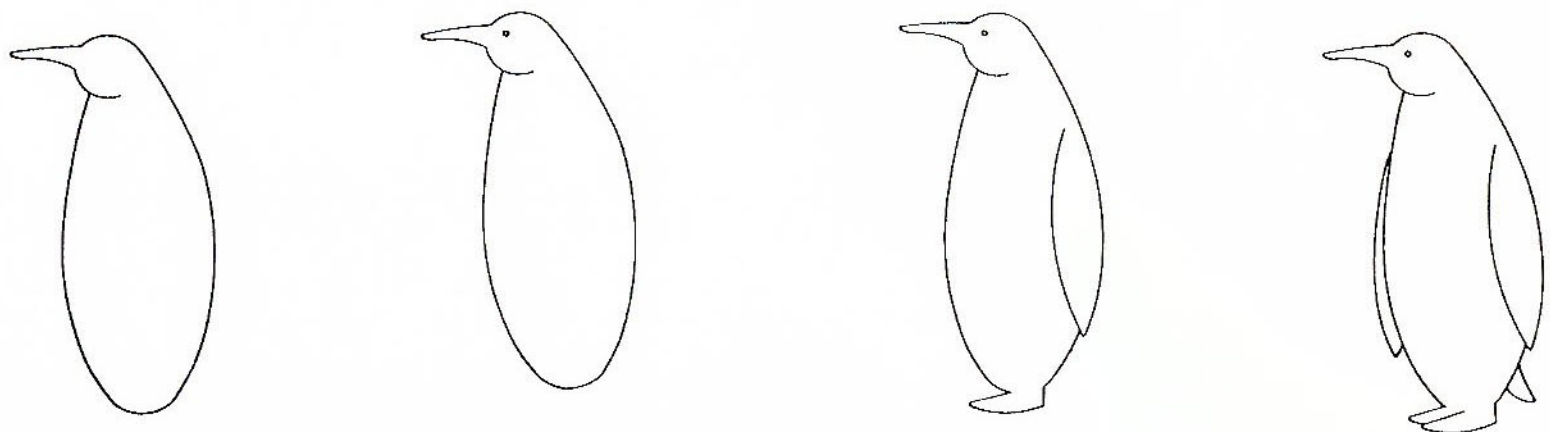

**Allows recognition when the object is partially occluded**

(a)

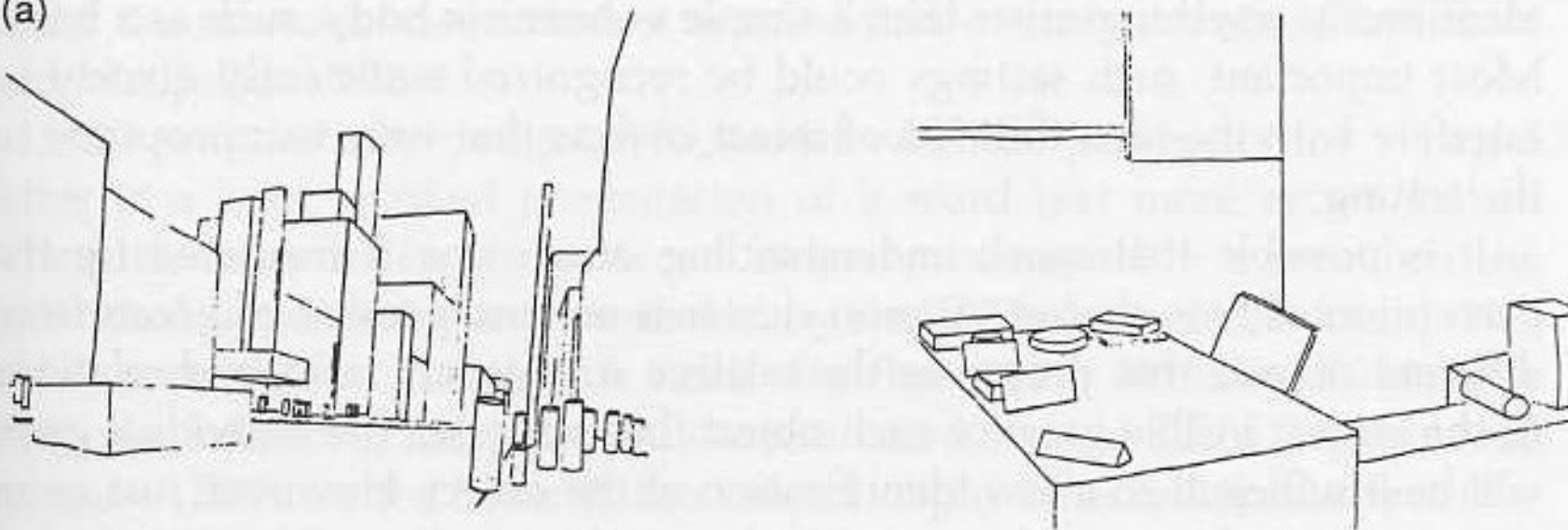

**Setting classification may be mediated by learned *clusters* (or “*scenelets*”) of simple shapes (geons). Humans may have stored tens of thousands of such scenelets.**

(b)

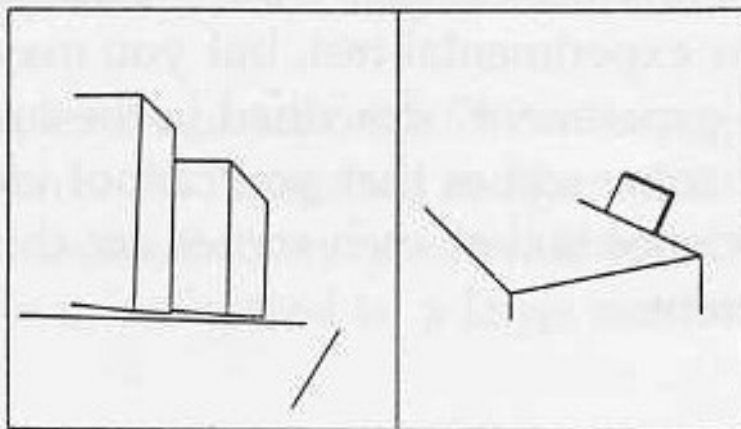

**Scenelets  
equivalent to  
parts-based  
object  
representations.**

**With a “vocabulary” of shapes, novel objects can be formed from different parts. People agree about how to decompose such objects into their parts and their (non-shape) texture regions.**

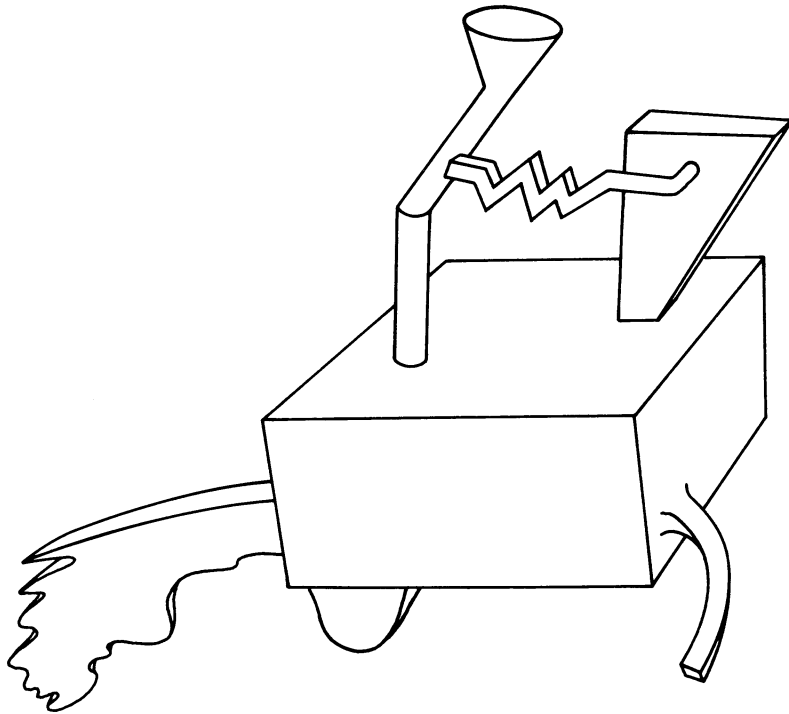

“This  
Way”  
Robert  
Hague

# Transversality Regularity

How do we decompose complex objects into their component parts? Matched cusps are formed when parts are combined. The cusps provide a natural way to decompose complex objects into *convex* (or *singly concave*) parts.

(a)

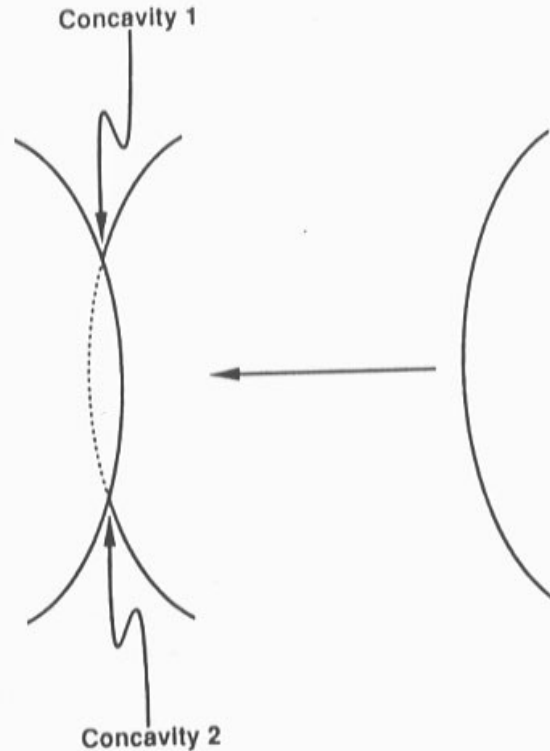

(b)

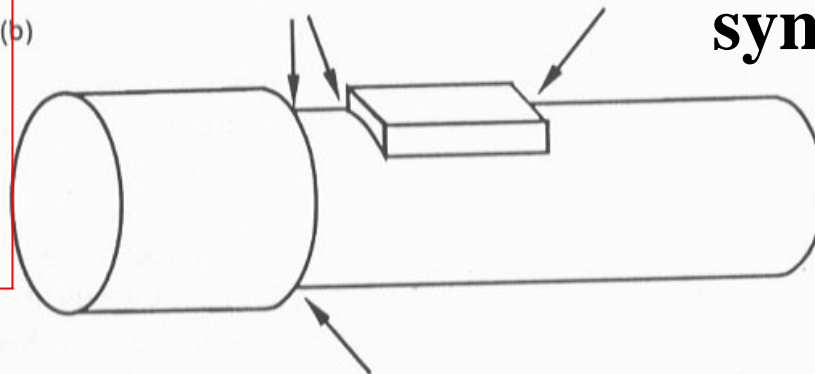

When ambiguous, parse object into simple, symmetrical parts.

**The distinction between concave vs. convex shape regions is made as early as V4. Cells responding to convex shapes (which are most of them) do not respond to concave shapes and vice versa.**

CONTOUR FEATURES IN AREA V4

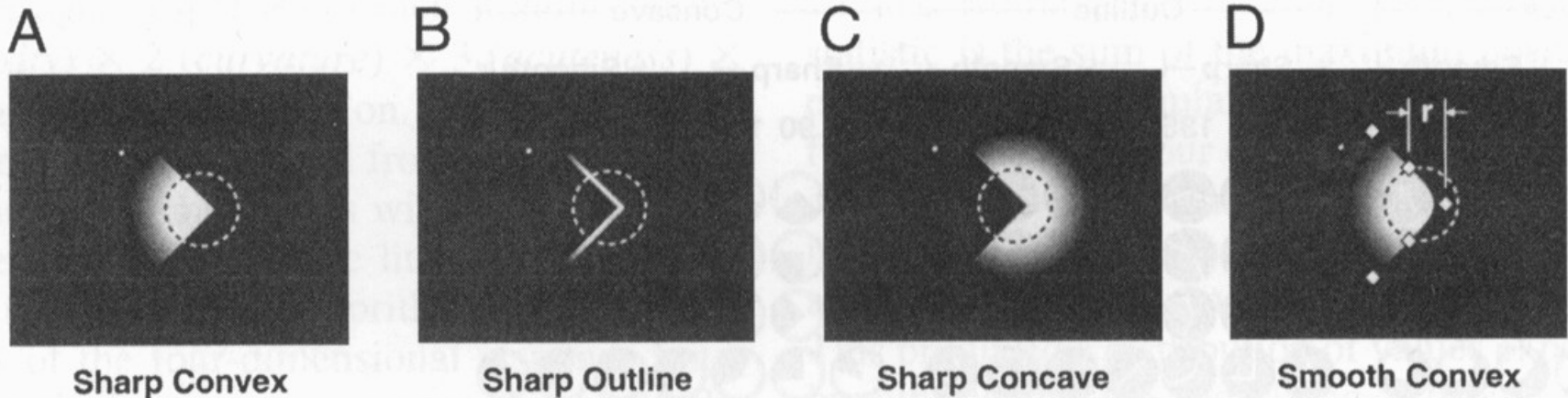

From Pasupathy & Connor, 1999, *J. Neuroscience*.

**By V4, therefore, the information required to implement the decomposition of complex objects into convex parts by matched cusps has already been made explicit.**



**In the absence  
of distinctive  
nonaccidental  
properties,  
invariant  
recognition for  
depth-rotated  
novel objects is  
impossible**

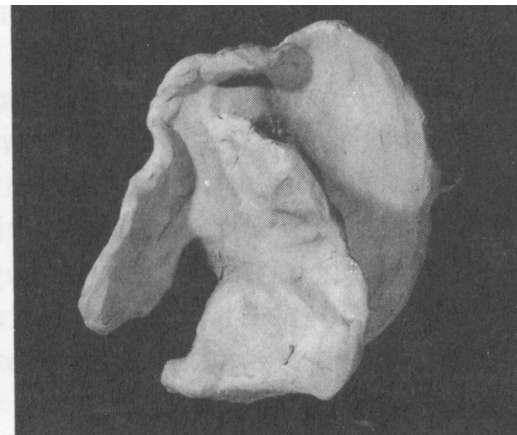
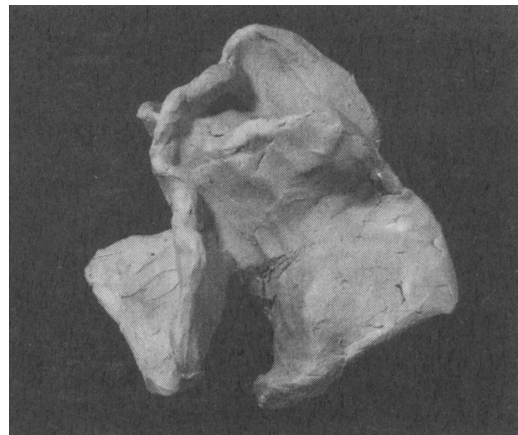
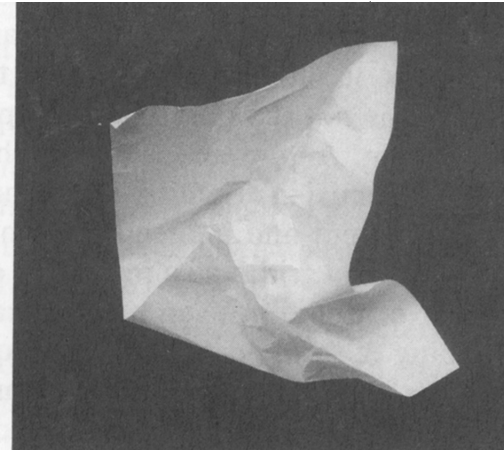
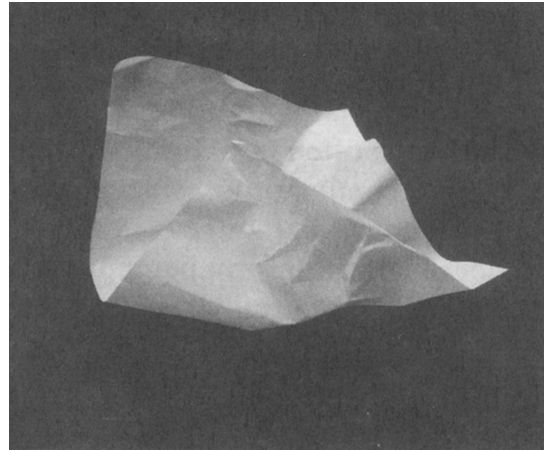
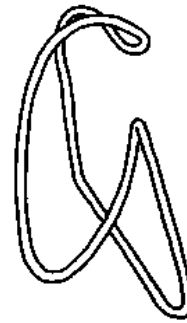
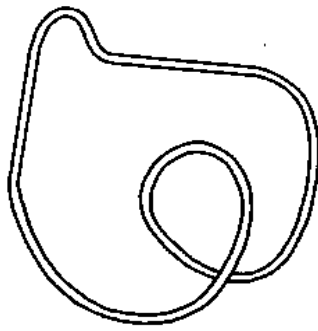

**Which one on the right is identical to the one on the left?**

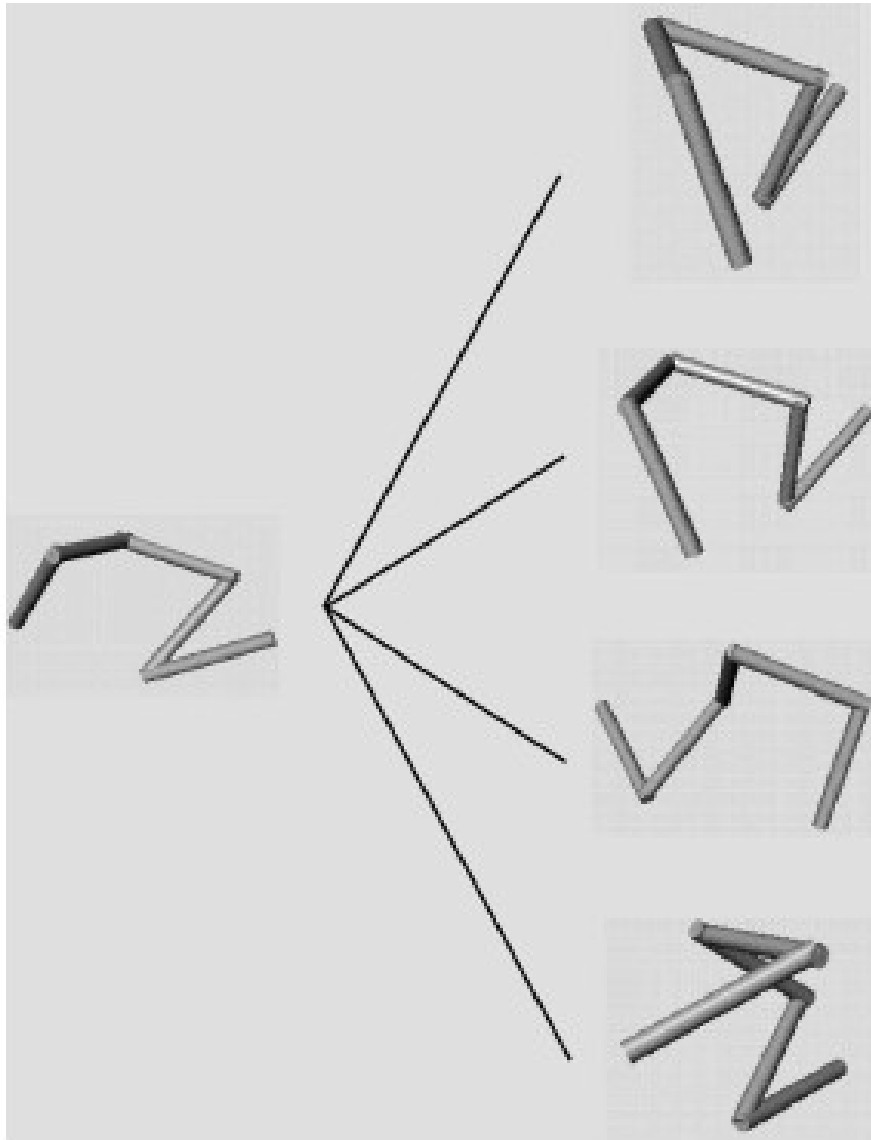

**<--- this one**

**Which one on the right is identical to the one on the left?**

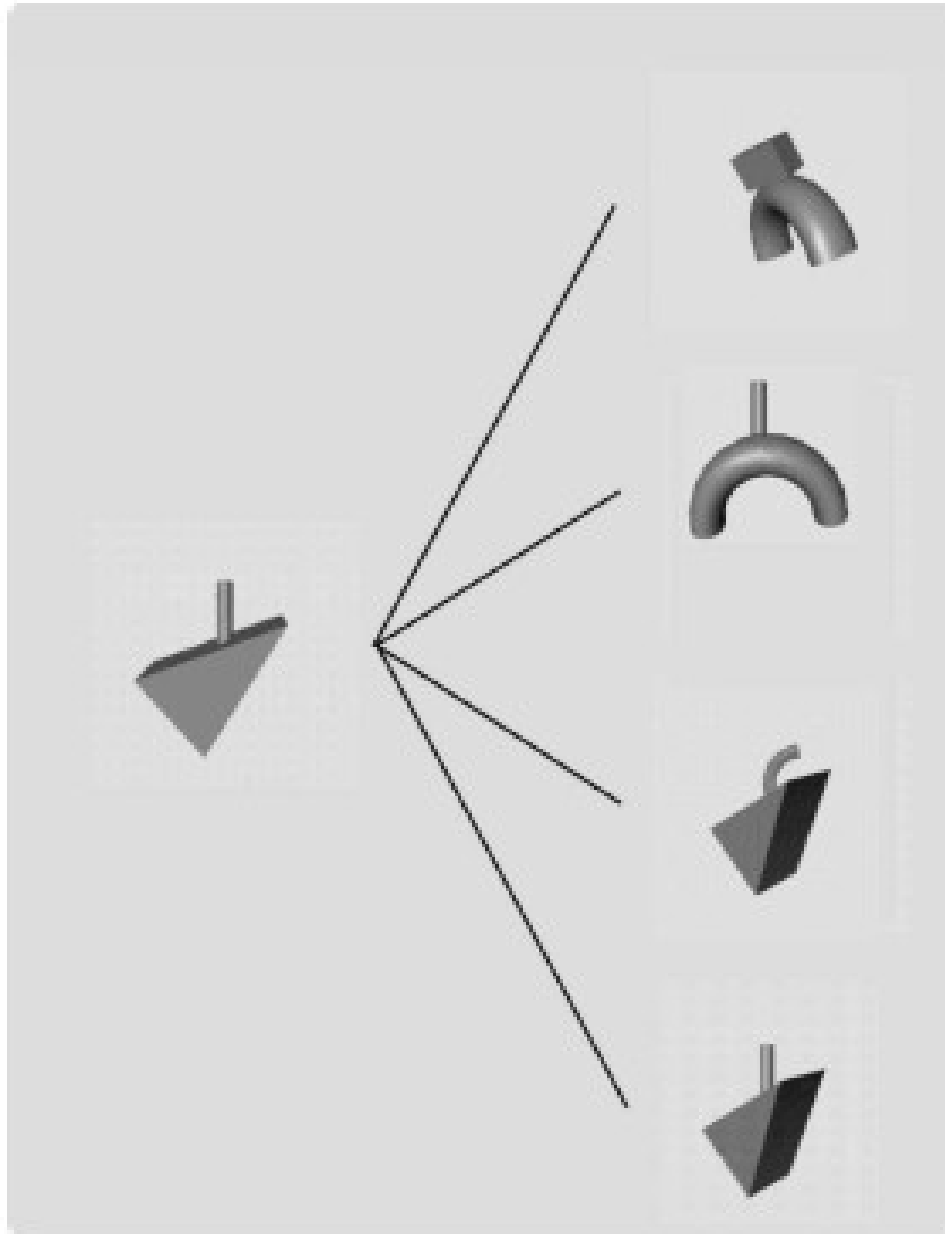

**Actually, none are identical.**

**The angle of attachment (a *metric* difference) of the cylinder to the wedge of the bottom object is different--but it is the object most similar to the object on the left.**



# Using Fast Event-Related fMRI-Adaptation to Determine if Representation in LOC is Discontinuity Based

Different Objects

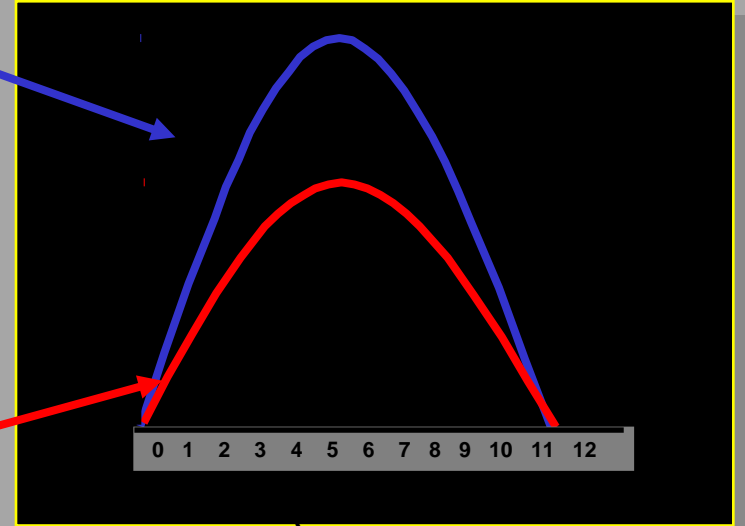
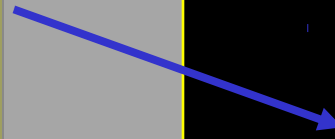
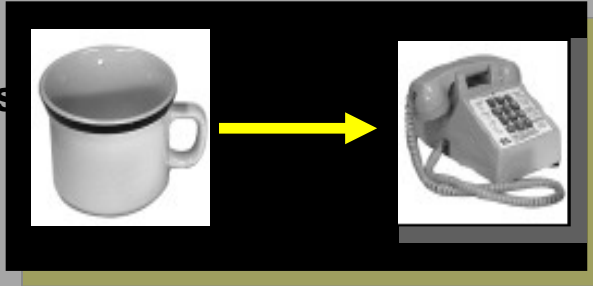

Same Objects

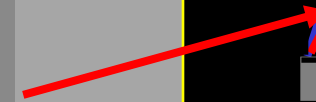
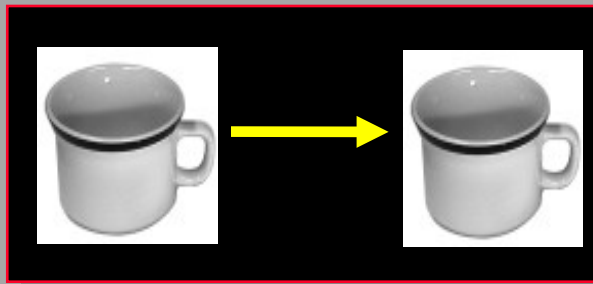

Critical Change

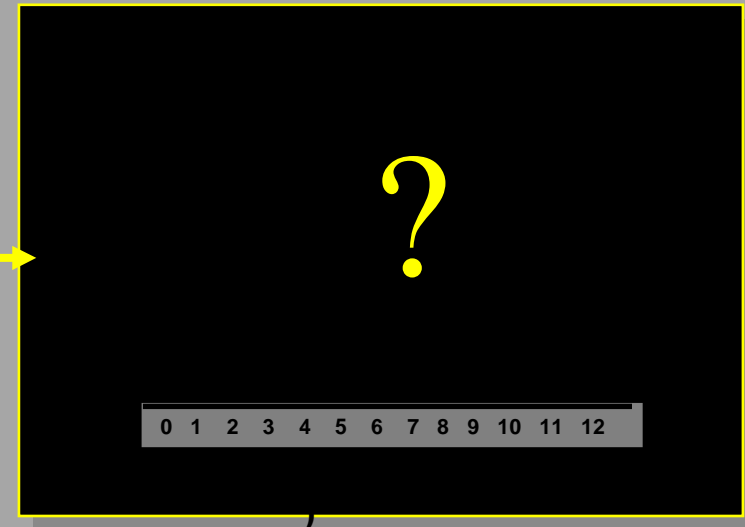
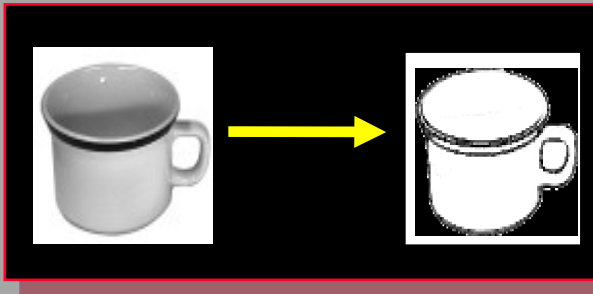

# fMRI-A (Adaptation). Reduced activity from repeated stimuli —independent of “format”--in LOC.

The equivalence of same vs. difference “format” is evidence that the representation is based on a line drawing of discontinuities.

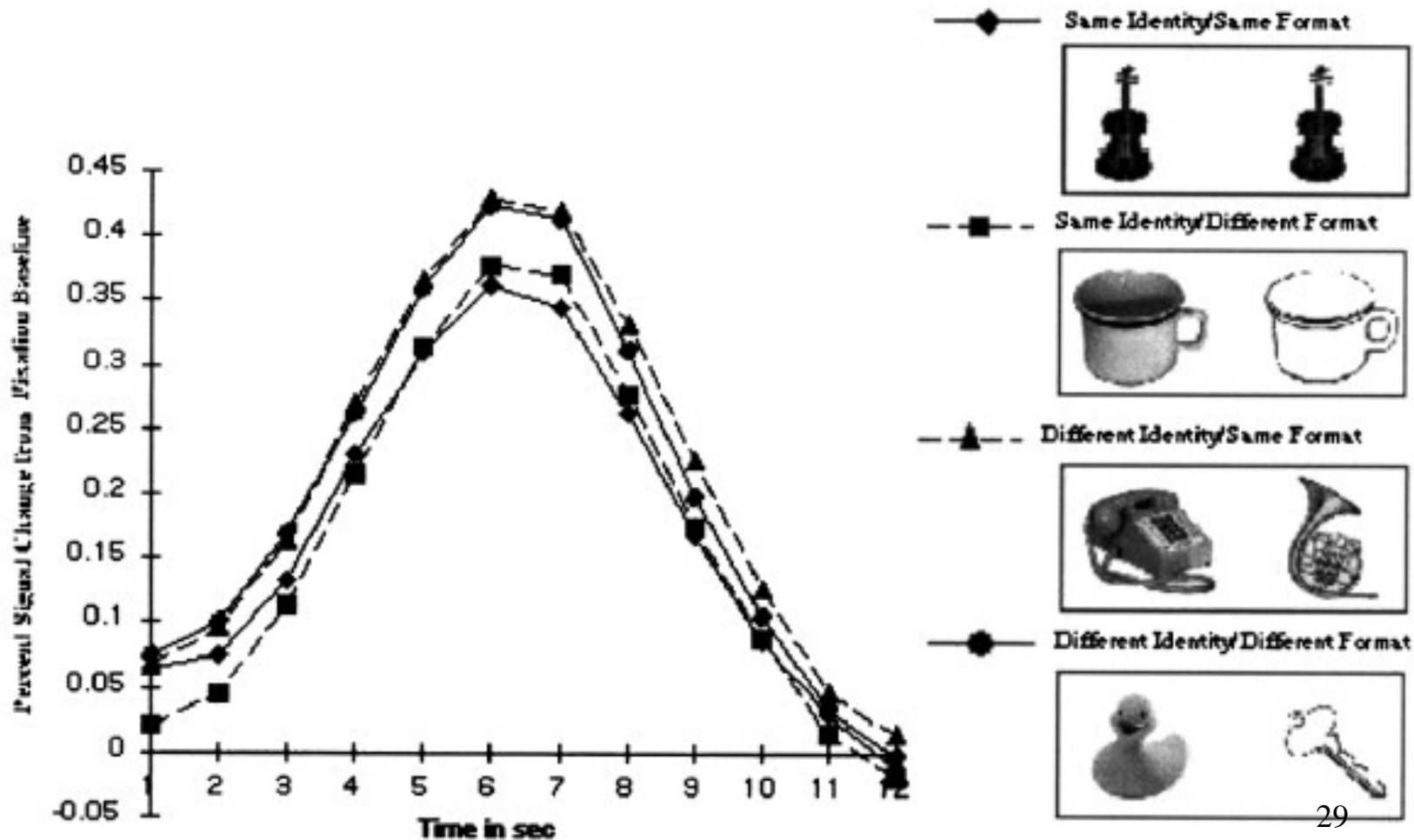

**FRONT**

**LEFT**

**RIGHT**

**BELOW**

**ABOVE**

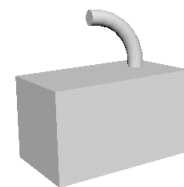
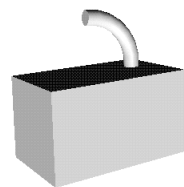
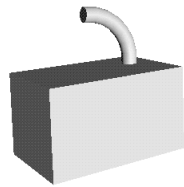
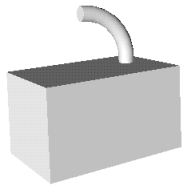
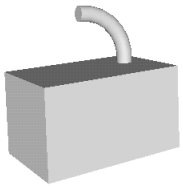
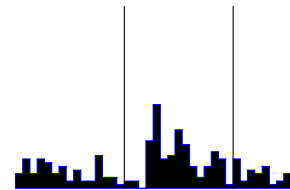
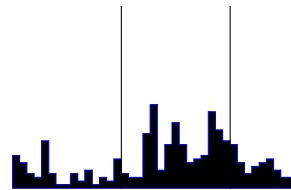
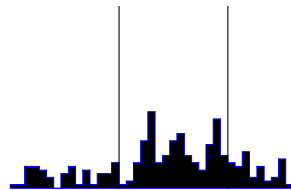
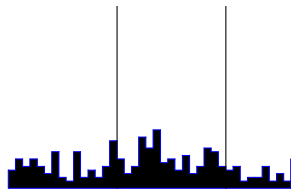
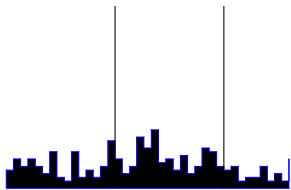
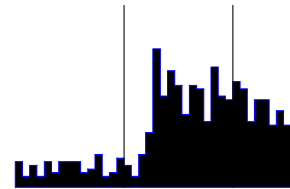
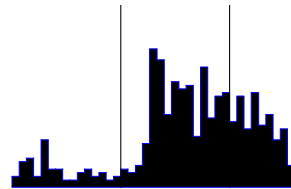
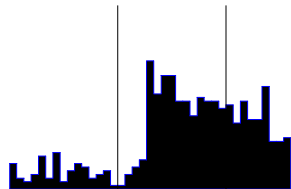
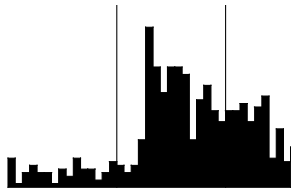
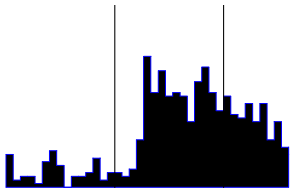
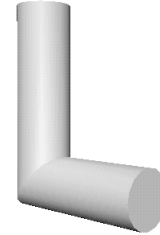
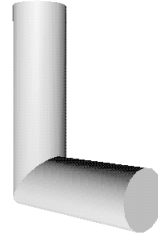
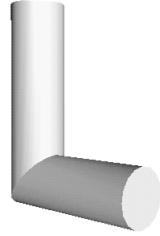
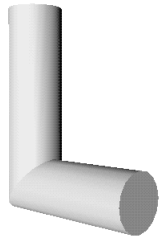
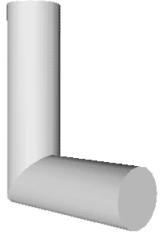

**ba98**  
s

*Effects of illumination intensity and direction on object coding in macaque inferior temporal cortex.*  
Vogels & Biederman, 2002, *Cerebral Cortex*.

## Nonrecoverable

**A demonstration of the importance of parts:  
It is almost impossible to identify these objects when the contour is deleted in such a manner as to prevent recovery of the parts.**



Recoverable Nonrecoverable

**The recoverable images have as much contour (i.e., pixels) deleted as the nonrecoverable images but their identification is much easier.**





**Even with *less* contour than the nonrecoverable images, the recoverable images can be identified as long as two or three parts can be recovered.**

Recoverable    Nonrecoverable



Original Recoverable Nonrecoverable

**Unless the parts can be recovered from the image, recognition is almost impossible**

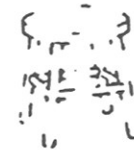
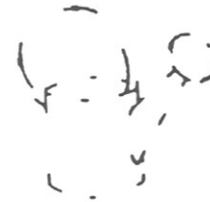
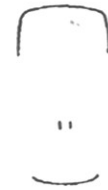

# VISUAL PRIMING OF PICTURE NAMING

- **Subjects name a series of briefly-presented pictures, shown one at a time, in a first block of trials.**
- **A second block of trials is then run in which the same pictures or pictures with the same name but a different shape are shown.**
- **Naming reaction times (RTs) and error rates are lower on the second block than on the first for the identical pictures.**
- **The identical pictures are named faster than the pictures with the same names but different shapes, indicating that a portion of the facilitation is visual and not just lexical or basic-level facilitation.**

# What mediates the priming of picture naming?

- **Local image features?** (The local features are required to activate the geons but is the memory representation specified in terms of the local features?)
- **Whole-object templates?**
- **Basic-level conceptual or lexical (or word production) priming?**
- **Subordinate-level conceptual priming?**
- **Parts?**

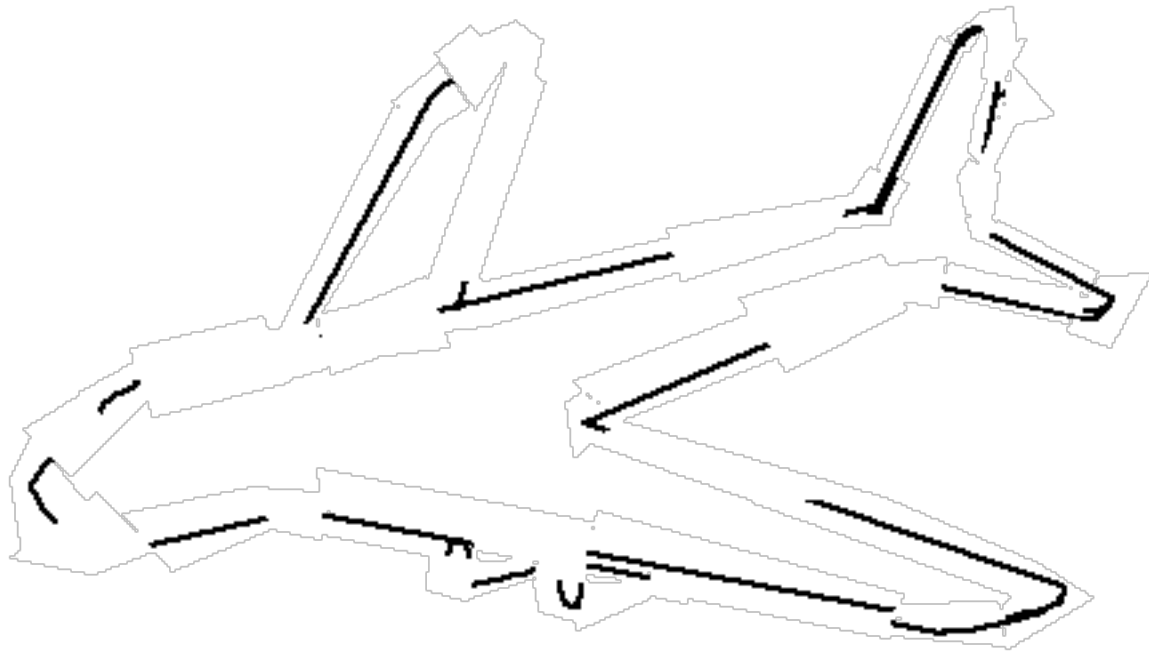

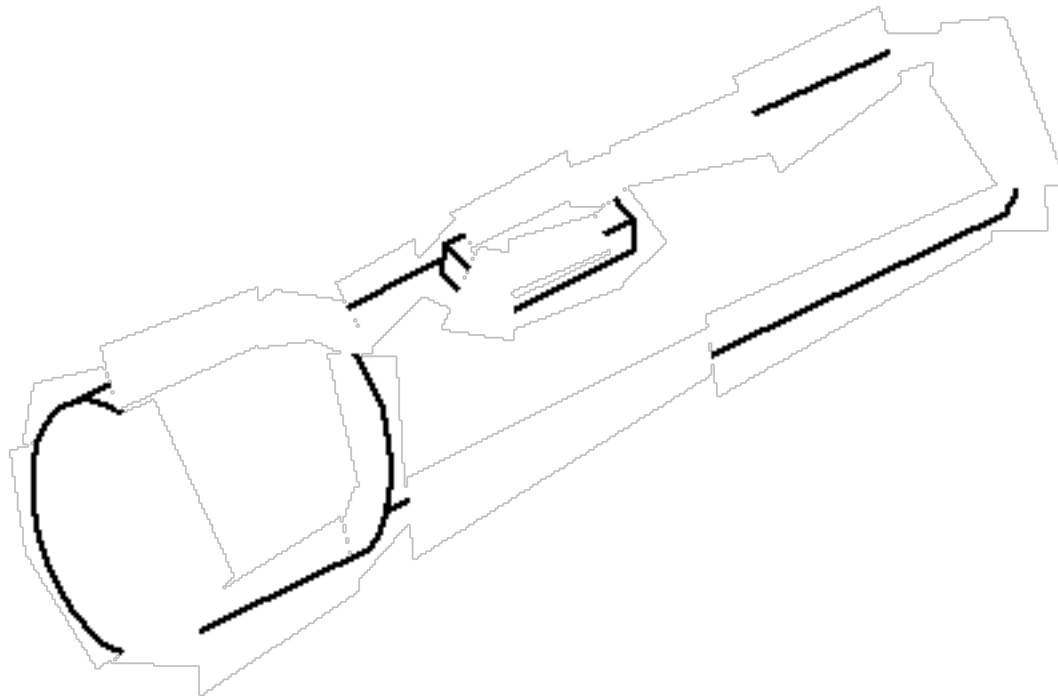

**Imagine you named 50 more objects in the first so now we have the second block ...**

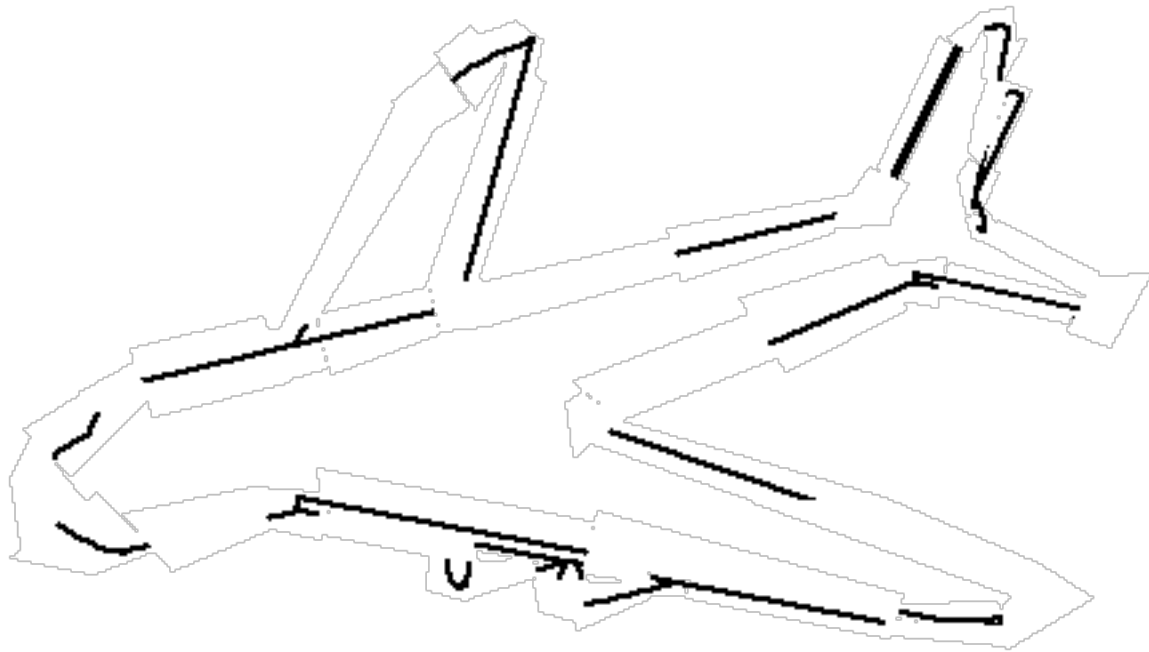



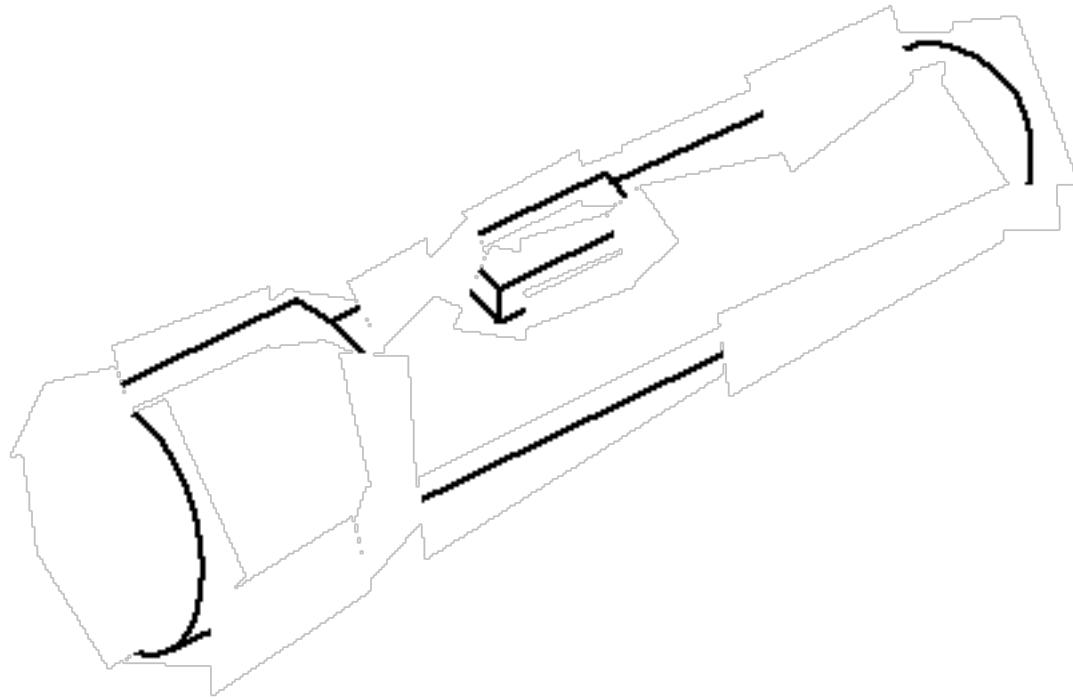

**Or we could have had a different exemplar of the airplane ...**



**or a different exemplar of the flashlight.**

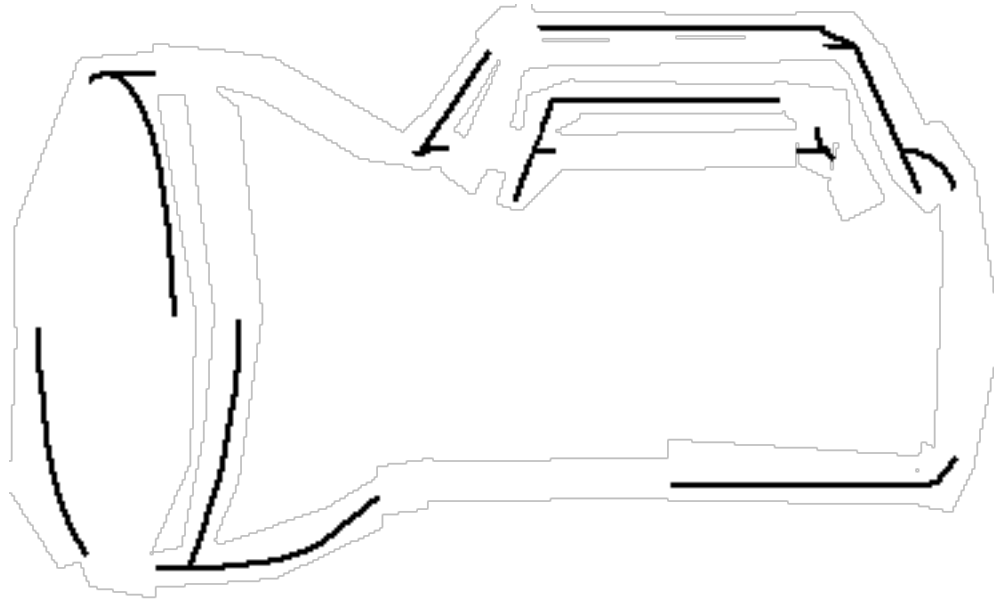

**Advantage of the Identical over the Different Exemplar Condition indicates that a portion of the priming was visual and not basic-level conceptual or verbal.**

**But what is this “Complement” condition?**

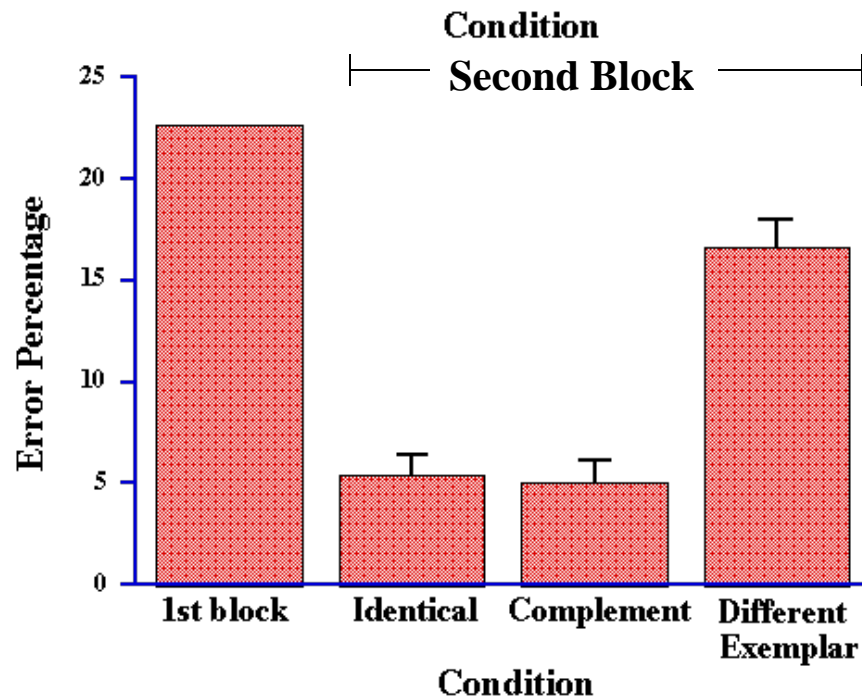
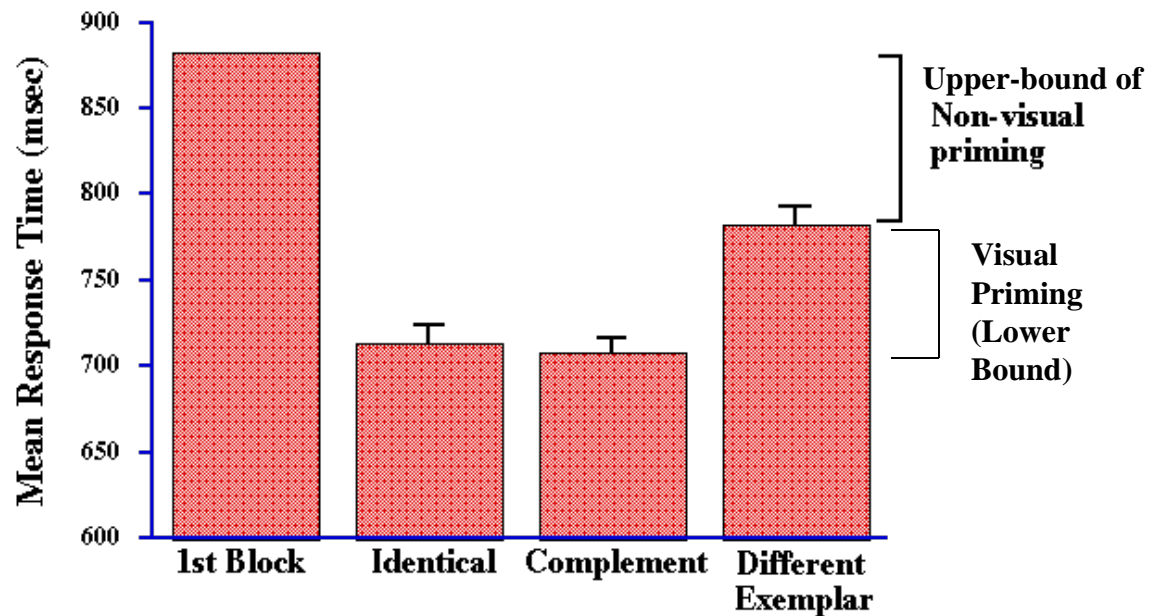

**The first airplane that you viewed.**

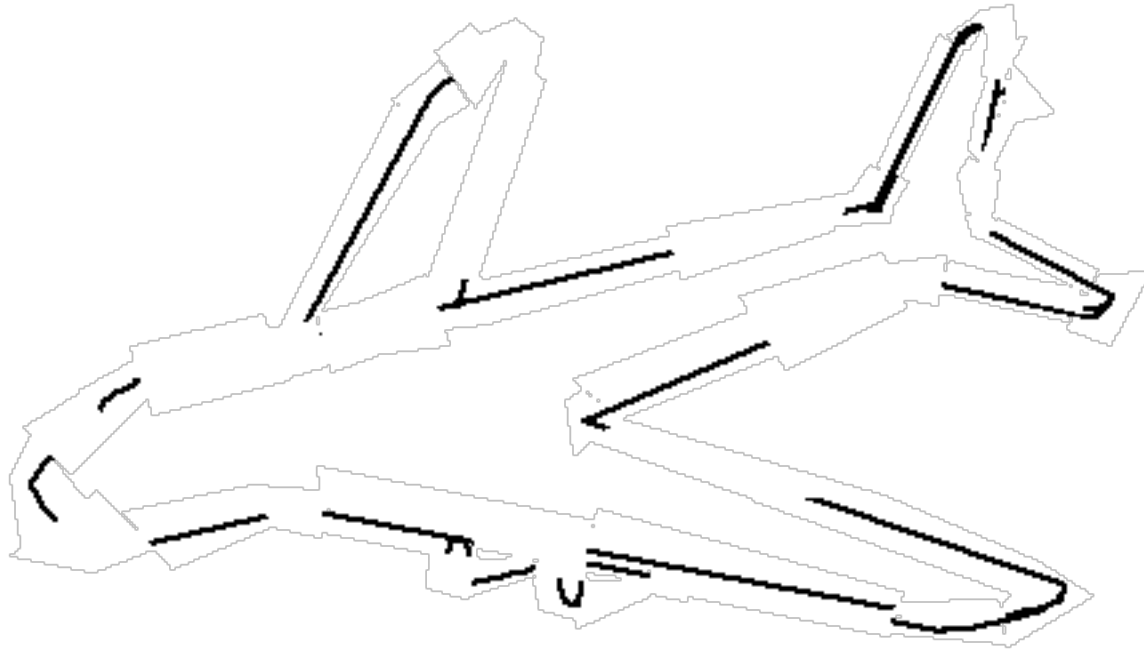

# The second airplane.

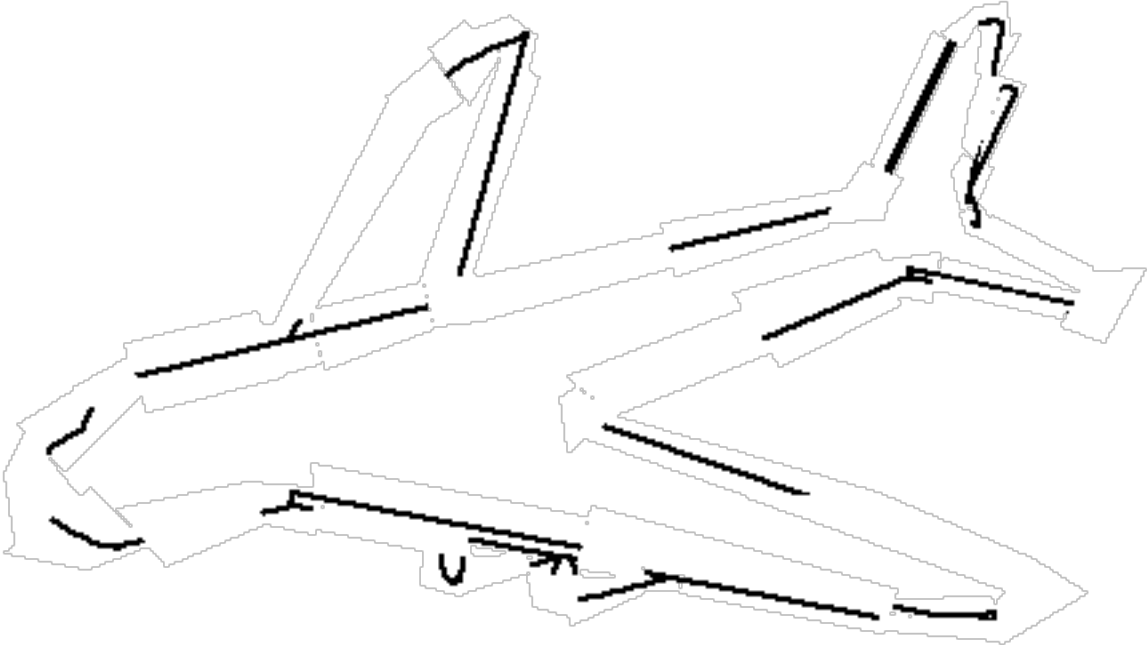

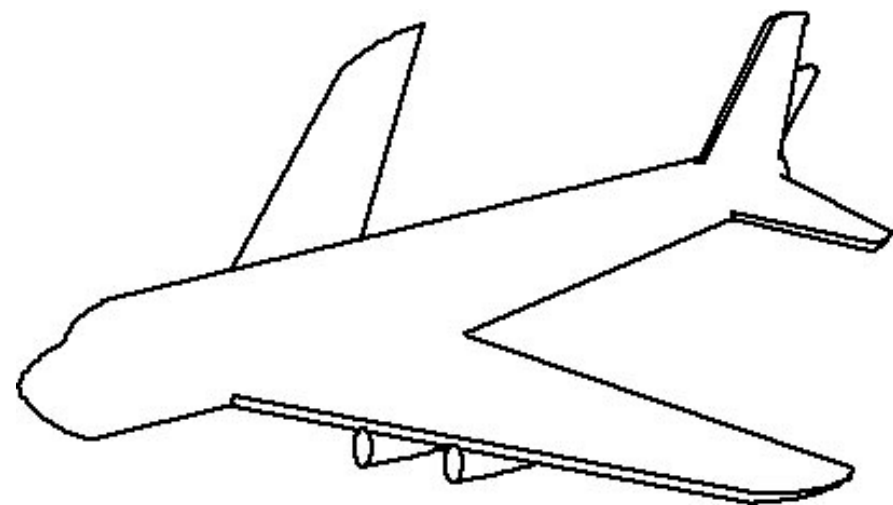
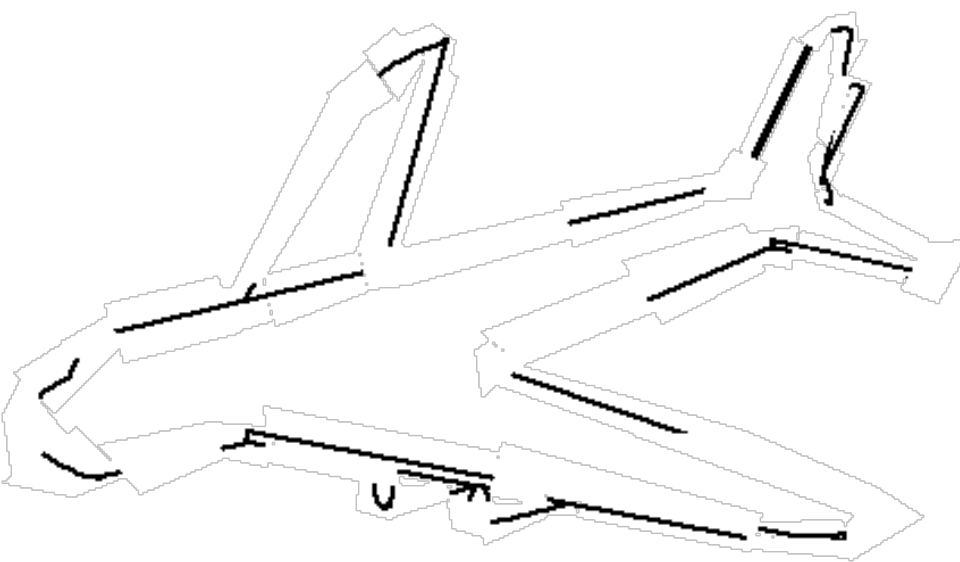
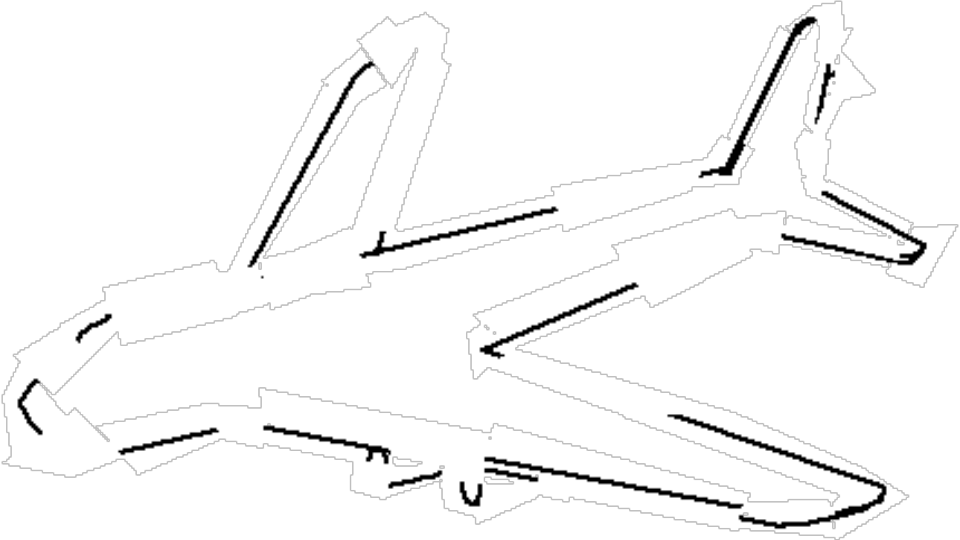

**The same parts are present, but every other vertex and line is deleted from each part of one image and put in the other.**

# The first flashlight.

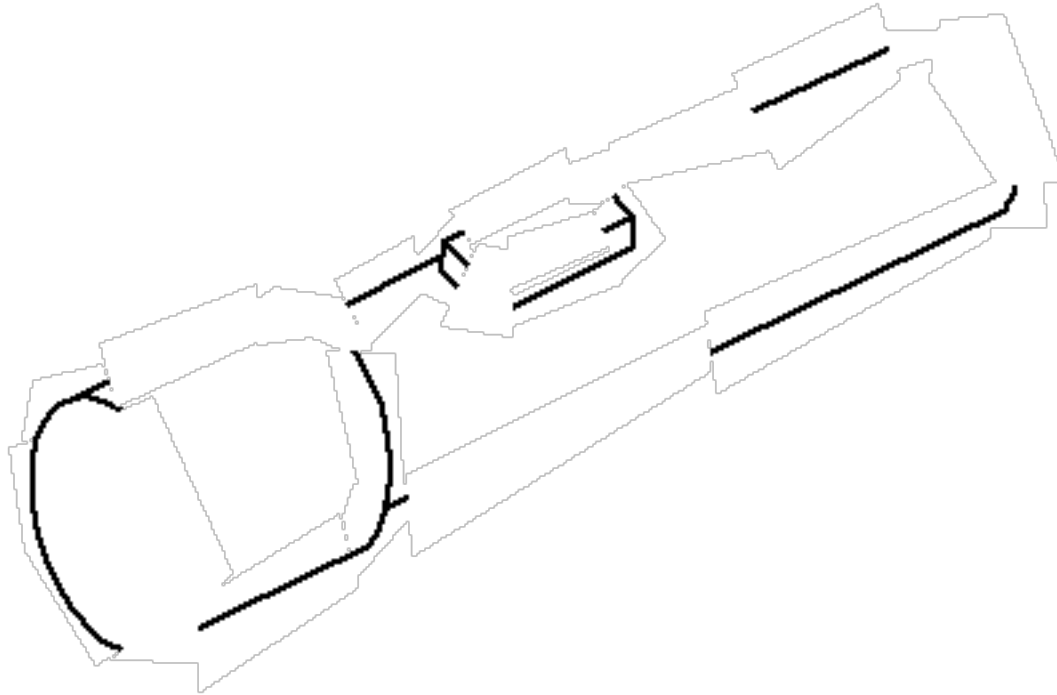



# The second flashlight.

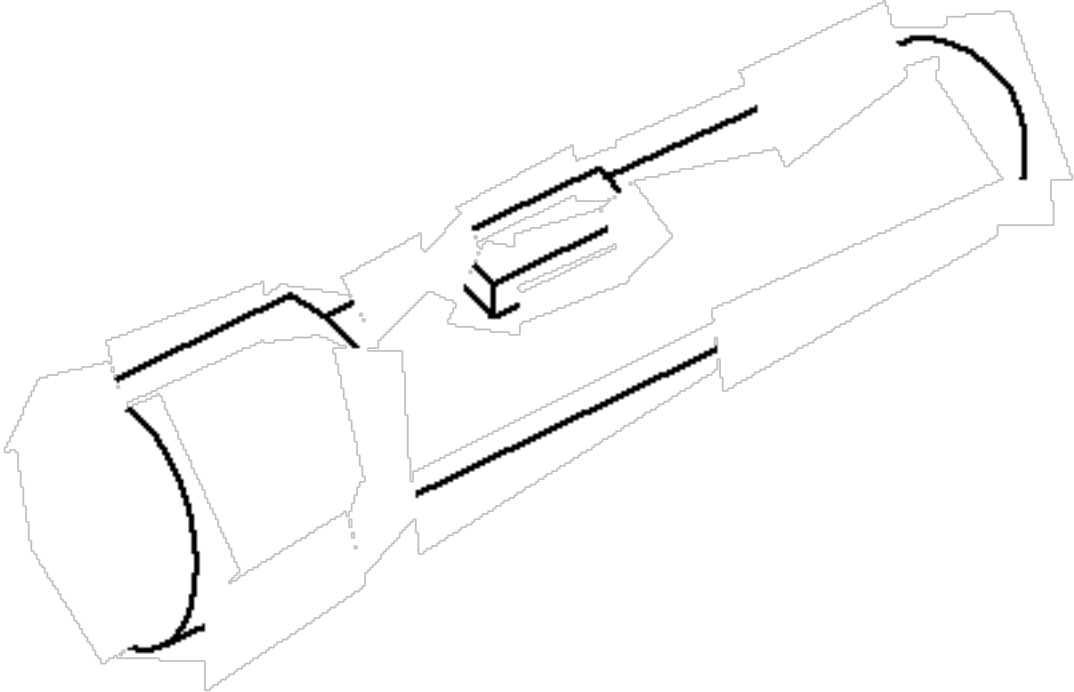

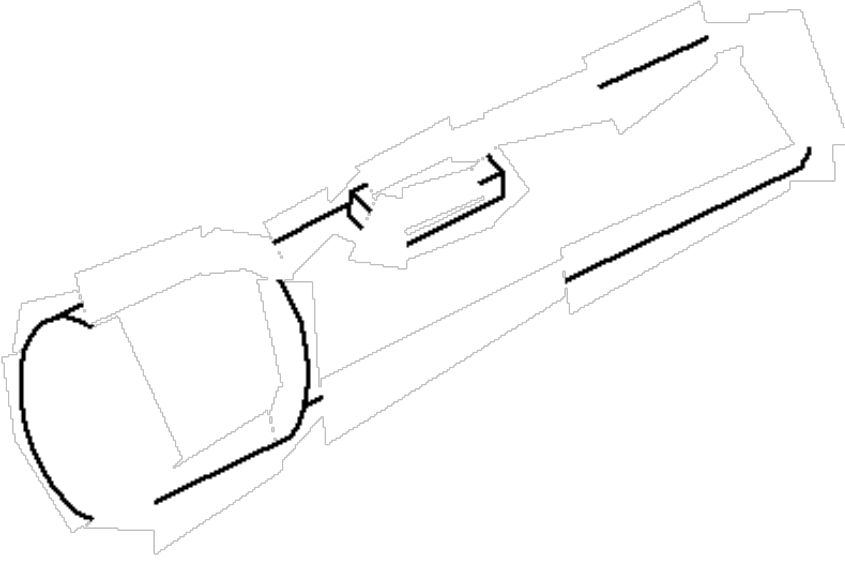

**Every other vertex and line is deleted from each part and placed in the other member of a complementary pair.**

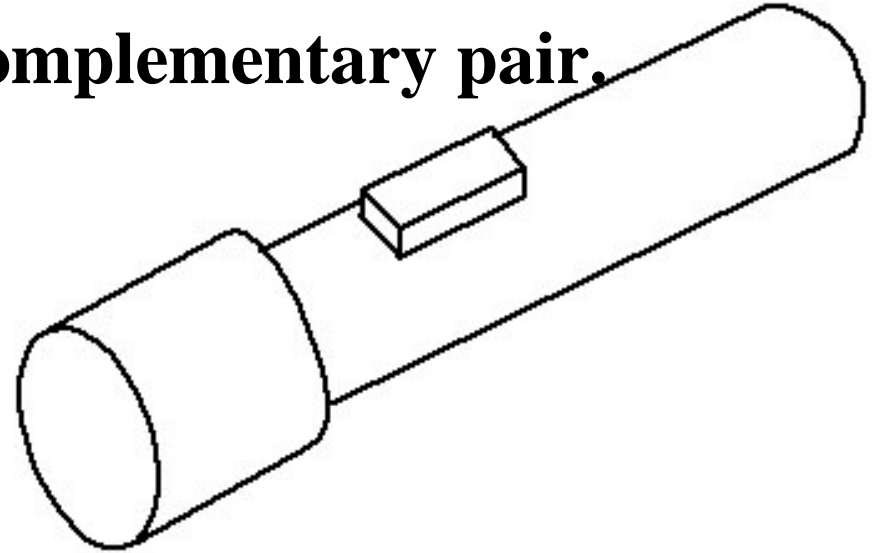

**If the two members of a pair of complementary images are superimposed they will produce the original image with no overlap in contour.**

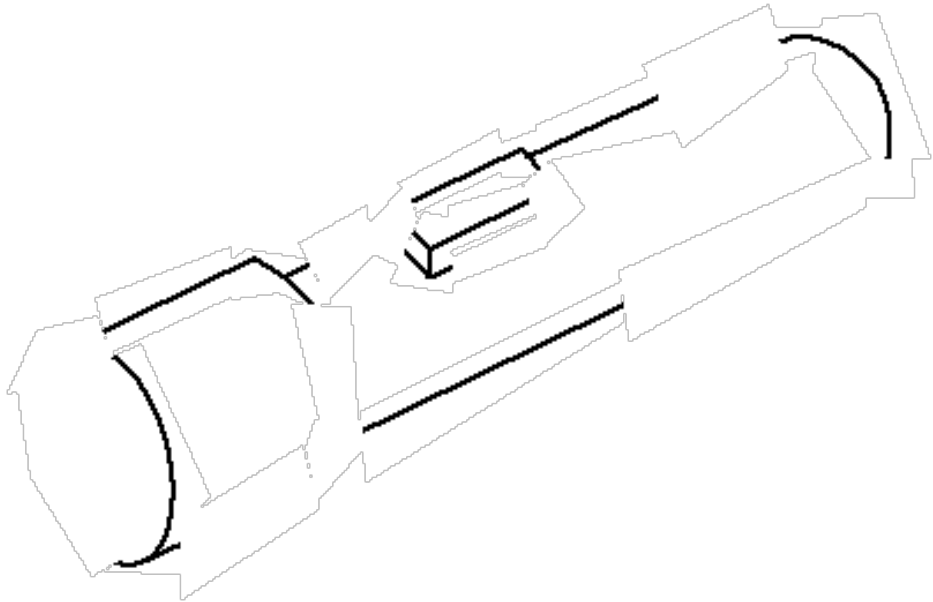

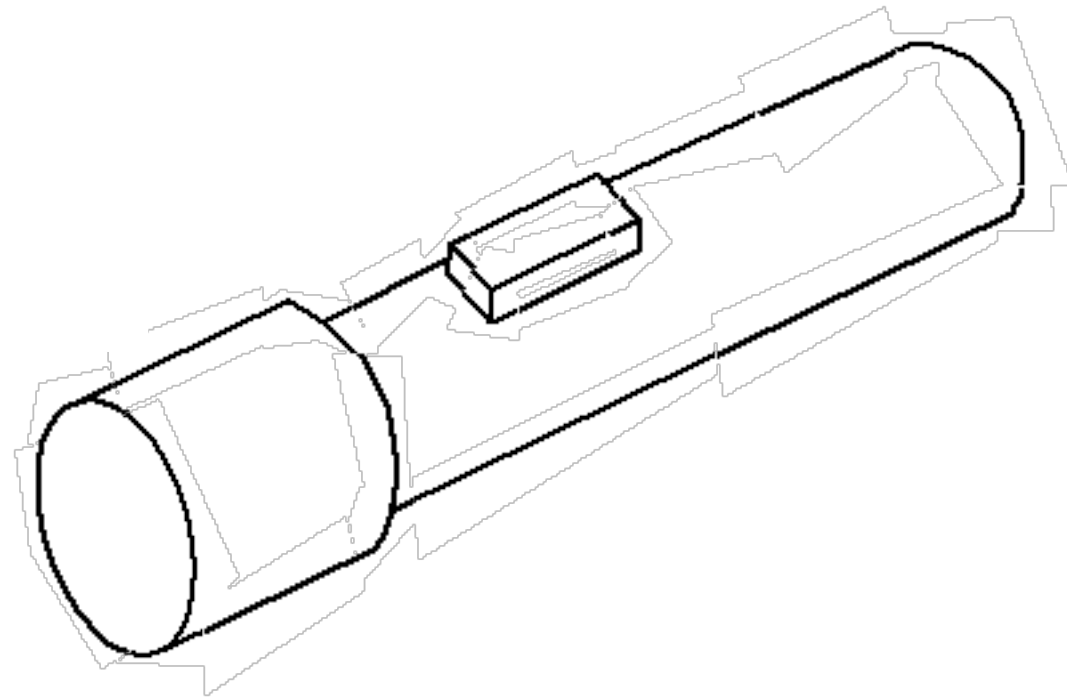

**Advantage of the Identical over the Different Exemplar Condition indicates that a portion of the priming was visual and not basic-level conceptual or verbal.**

**Equivalence of Complementary and Identical conditions indicates that *none* of the visual priming could be attributed to local features (contours and vertices).**

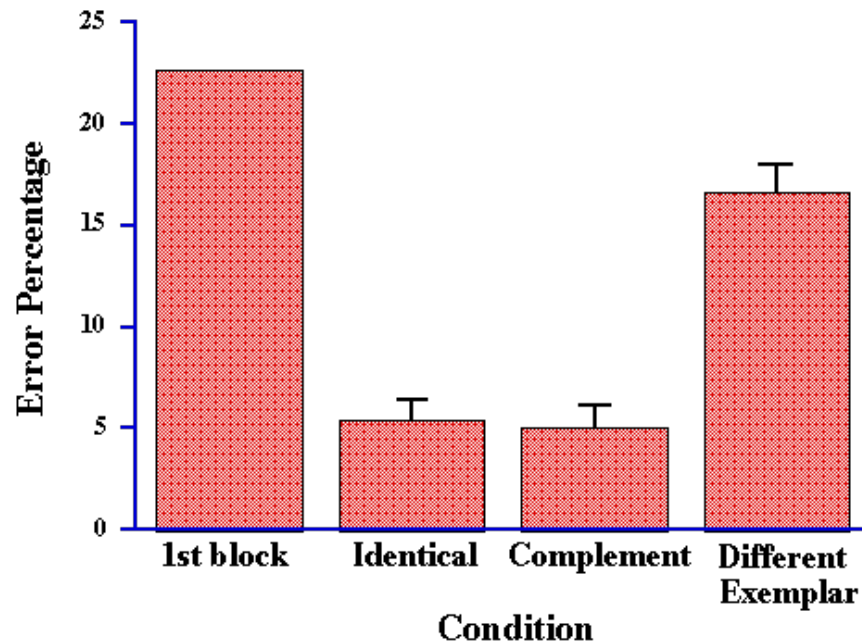
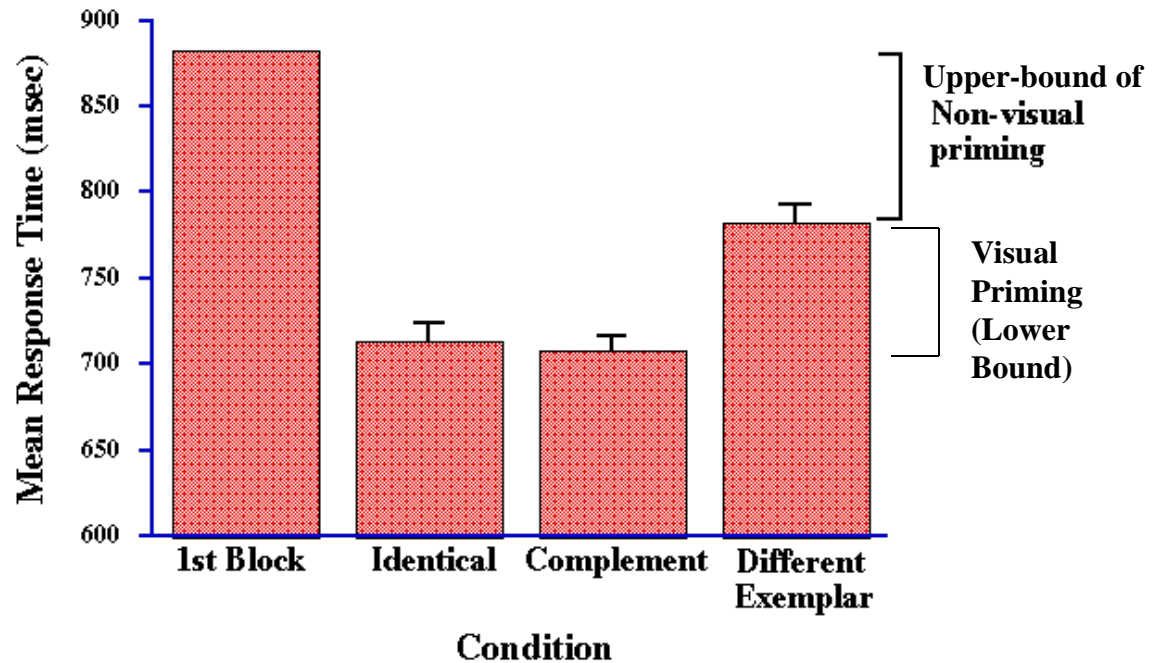

# Part Complements: Provide a test of subordinate level priming

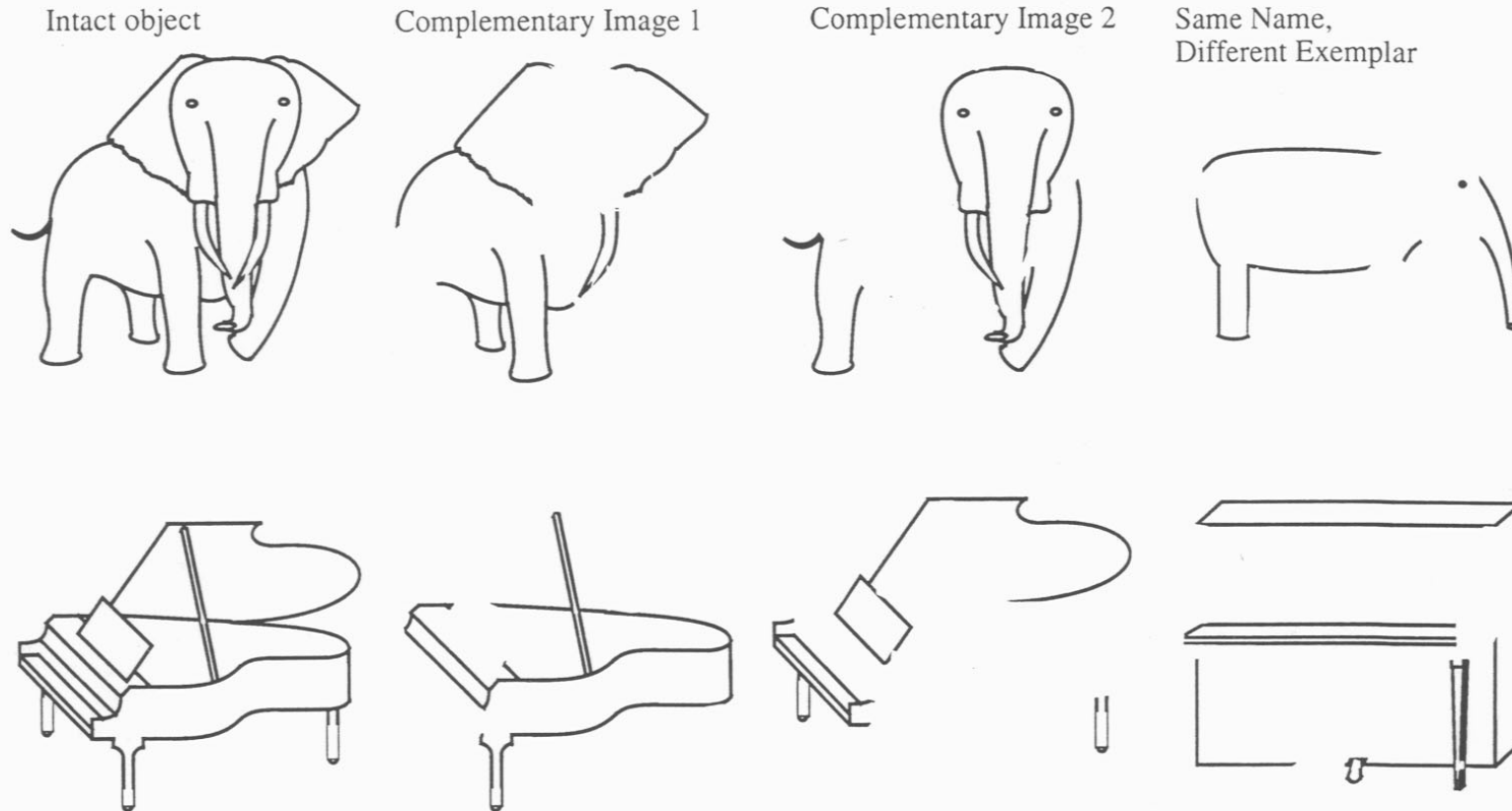

**These complements have no parts in common. If subordinate conceptual priming occurred, then Complements should be superior to the Different Exemplar condition. If visual priming requires common parts, then Complementary and Different Exemplar conditions should be equivalent.**

# RESULTS: PART COMPLEMENTS

Again, advantage of Identical over Different Exemplar conditions indicates that a portion of the priming was visual and not basic-level conceptual or verbal.

However, now performance on the Identical condition is superior to that of the Complementary condition which, in turn, is equivalent to the Different Exemplar condition, indicating *no* contribution of subordinate concepts to visual priming.

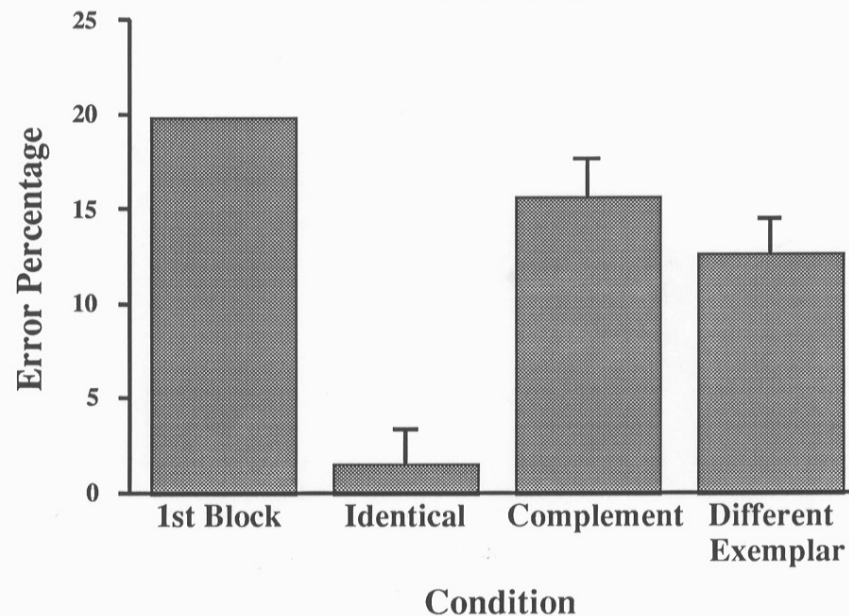
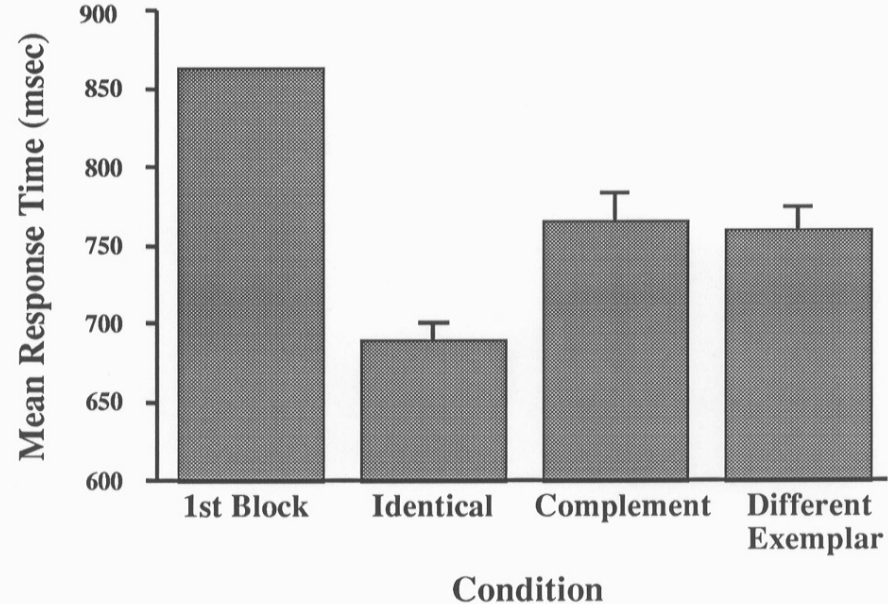

# What mediates the priming of picture naming?

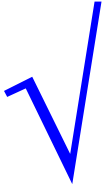
- Local image features? **X**
- Whole-object templates? **X**
- Basic-level conceptual or lexical (or word production) priming? **X**
- Subordinate-level conceptual priming? **X**
- Parts? 

# Example Feature-Deleted Trial with S2 Identical to S1.

**Note S1 and S2 are mirror  
reversed.**

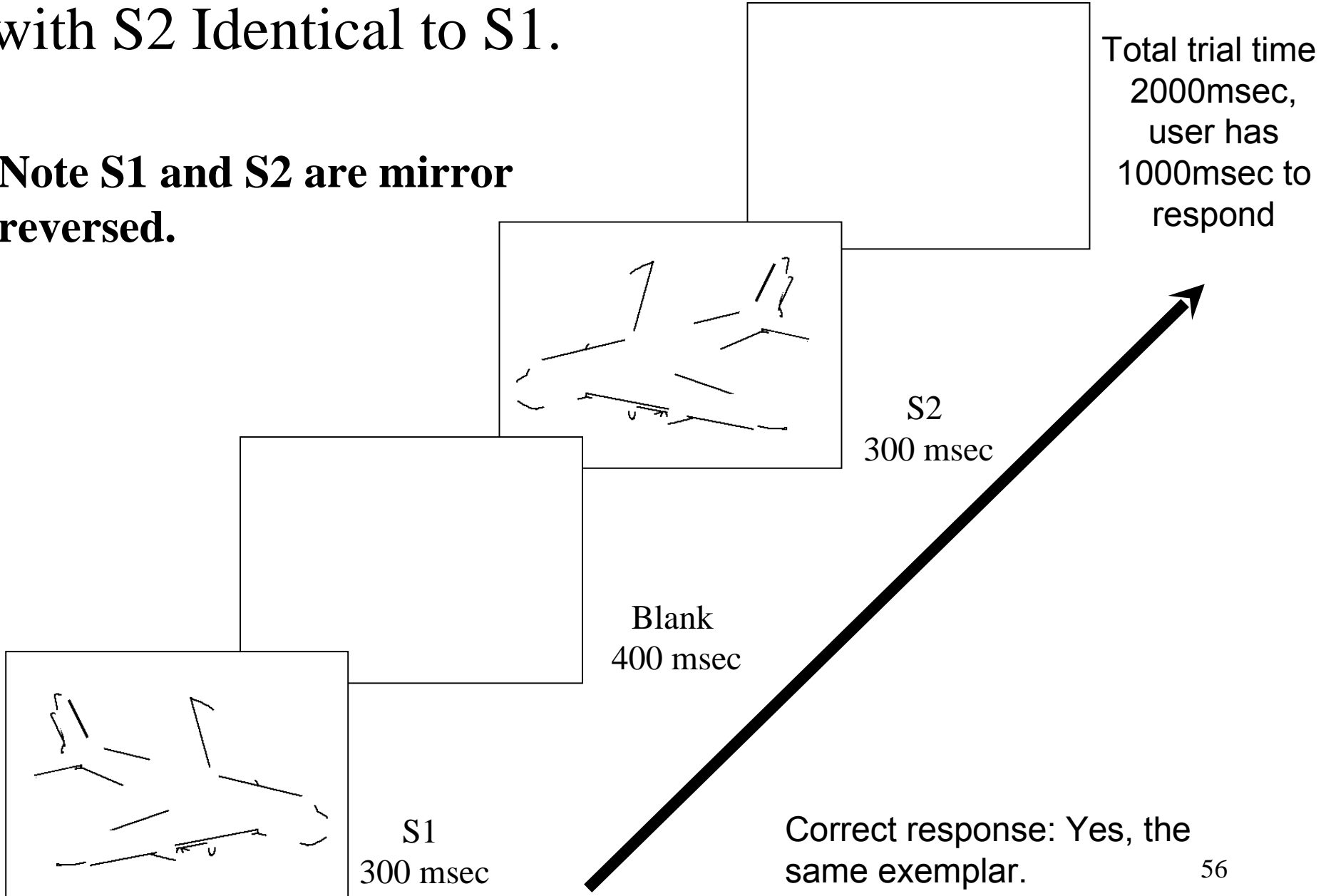



# Sample Feature-Deleted Stimuli

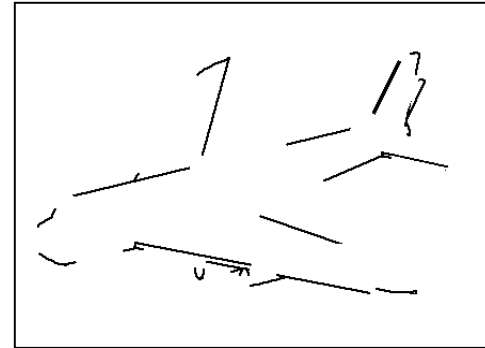
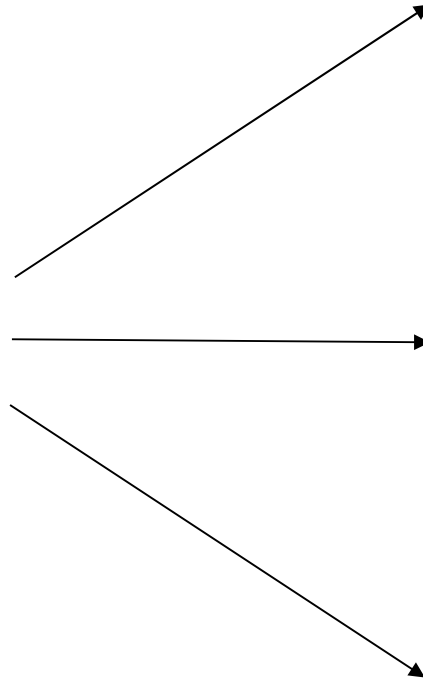
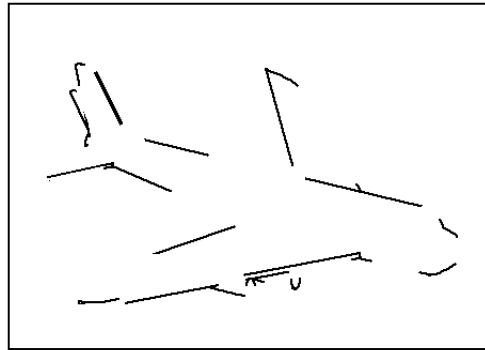

Identical

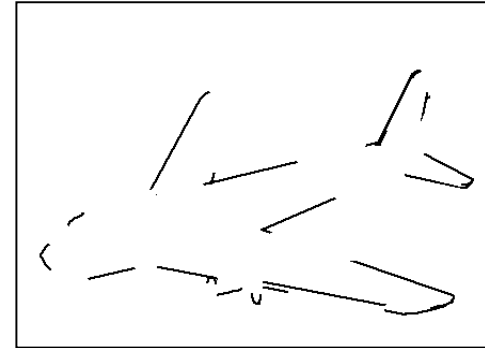

Complement

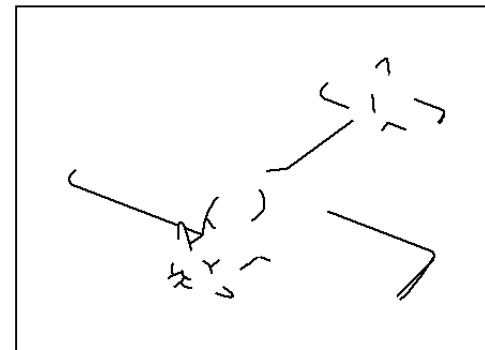

Different  
Exemplar

# Example Part-Deleted Stimuli

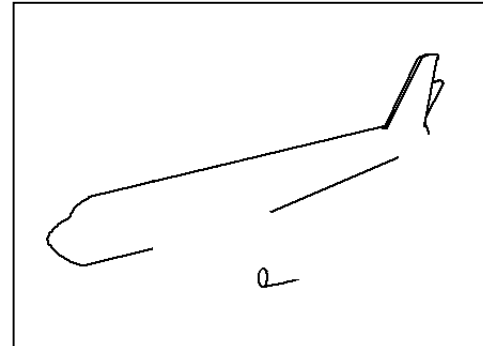
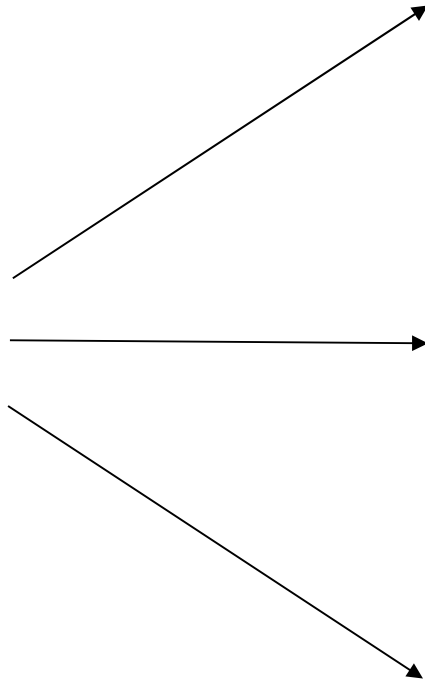
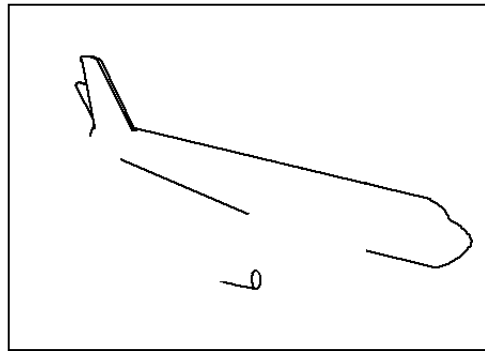

Identical

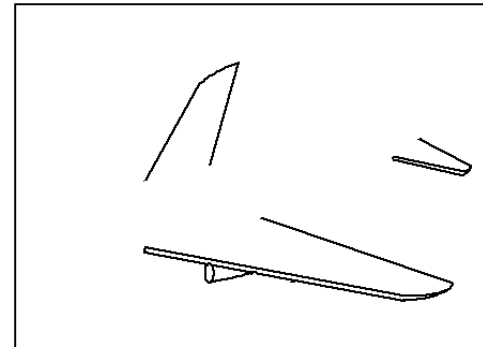

Complement

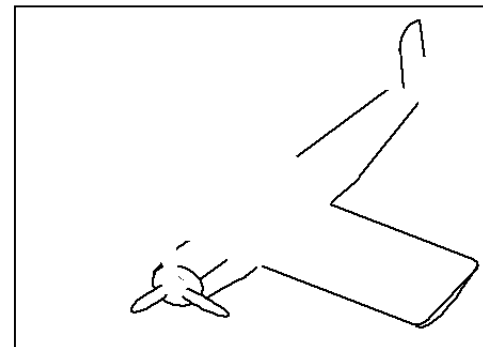

Different  
Exemplar

**LOC  
localizer  
with  
control for  
contour  
elements  
and  
aspect  
ratio**

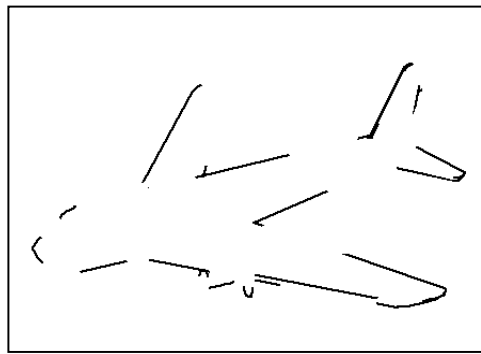

Scrambled  
→

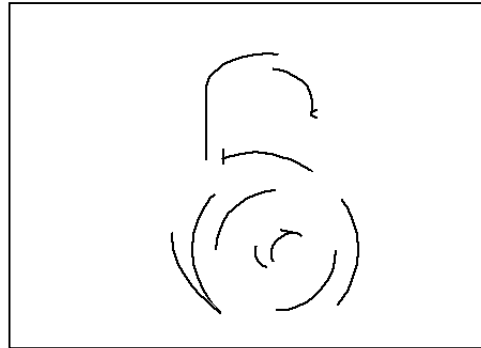
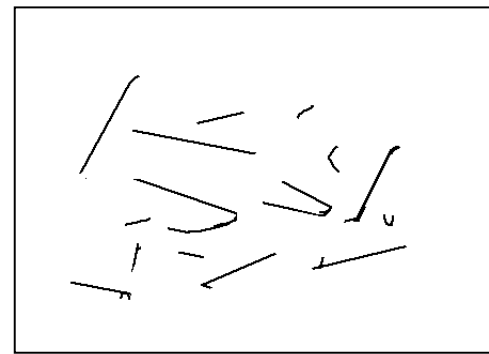

Scrambled  
→

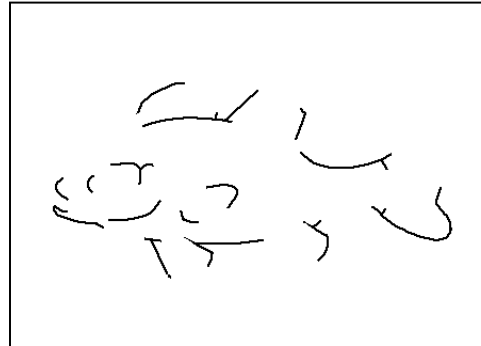
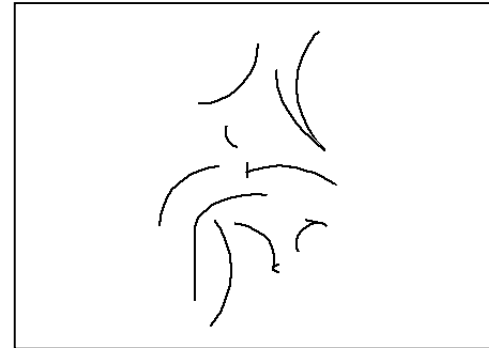

Scrambled  
→

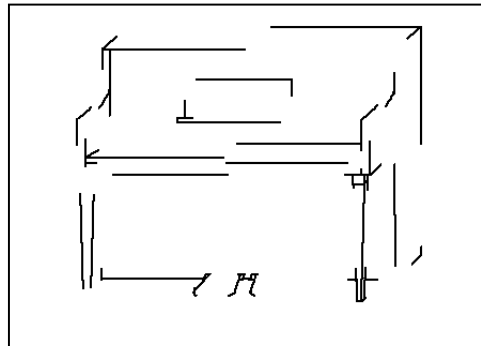
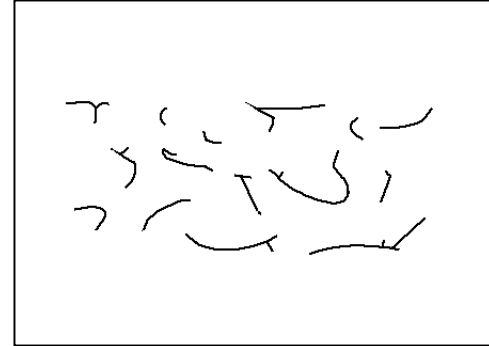

Scrambled  
→

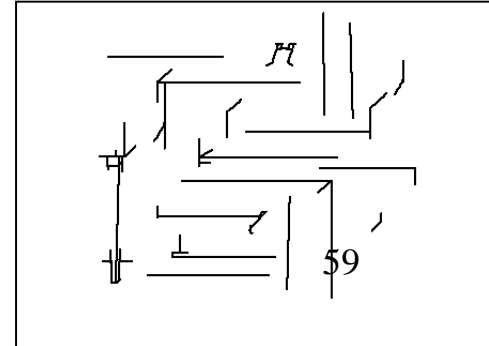

# Regions of Interest Defined with Scrambled Feature-Deleted LOC Localizer

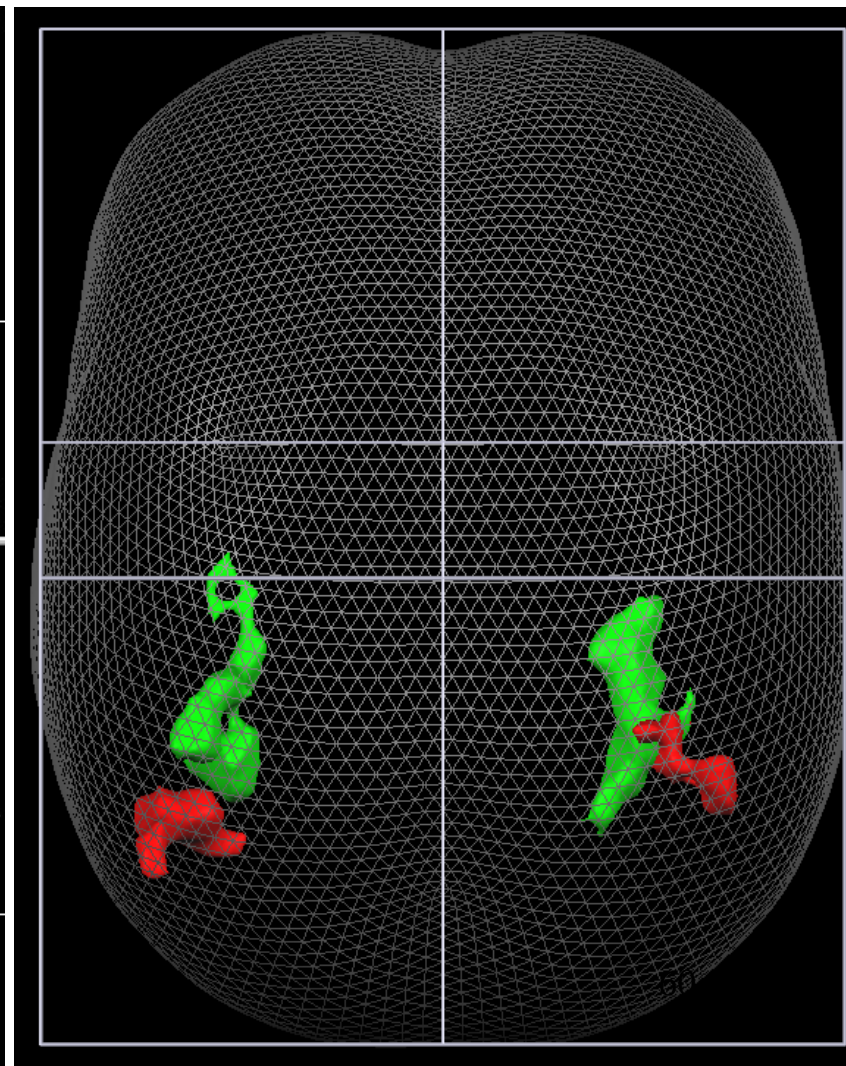
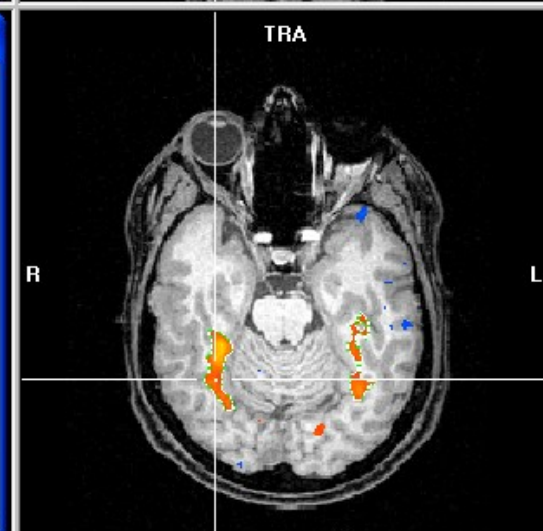
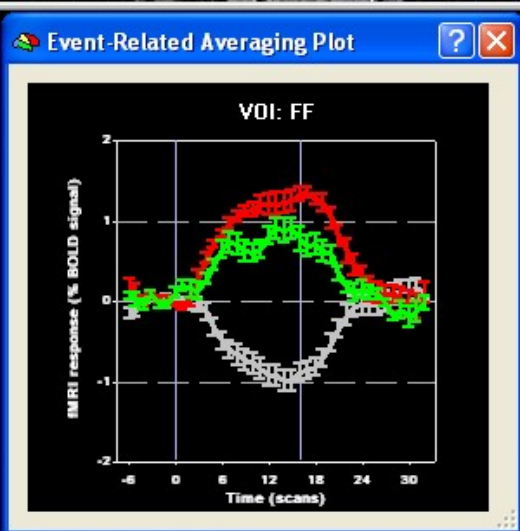
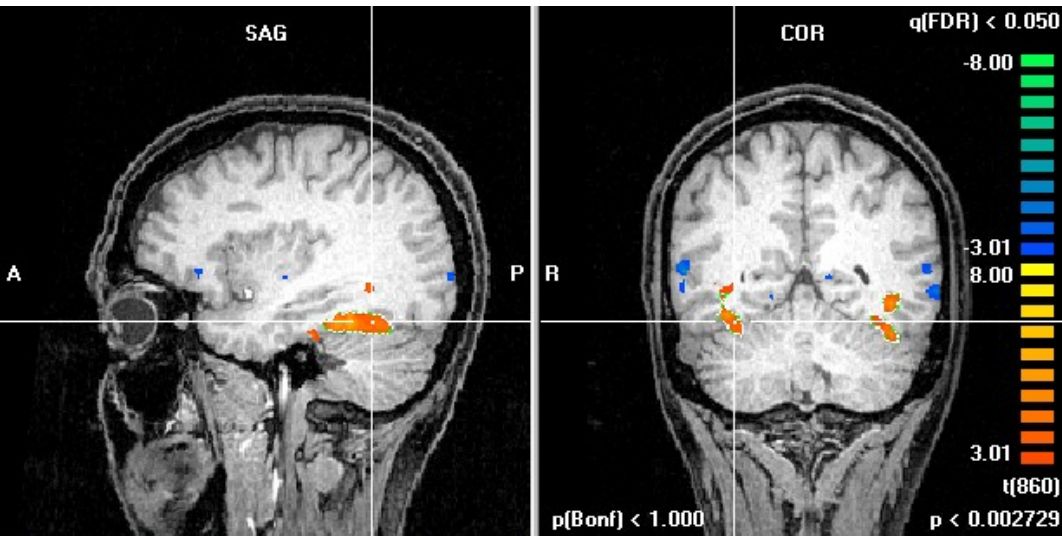

Event-related BOLD response (% change over fixation baseline) averaged over all subjects (n = 8) in the pFs region of LOC

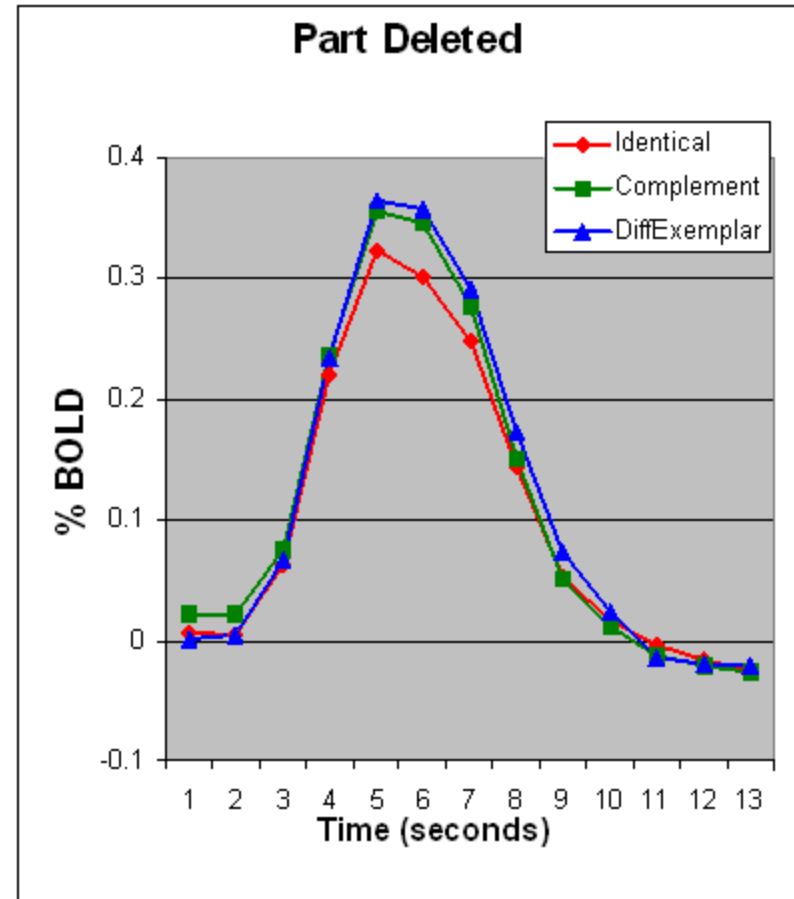
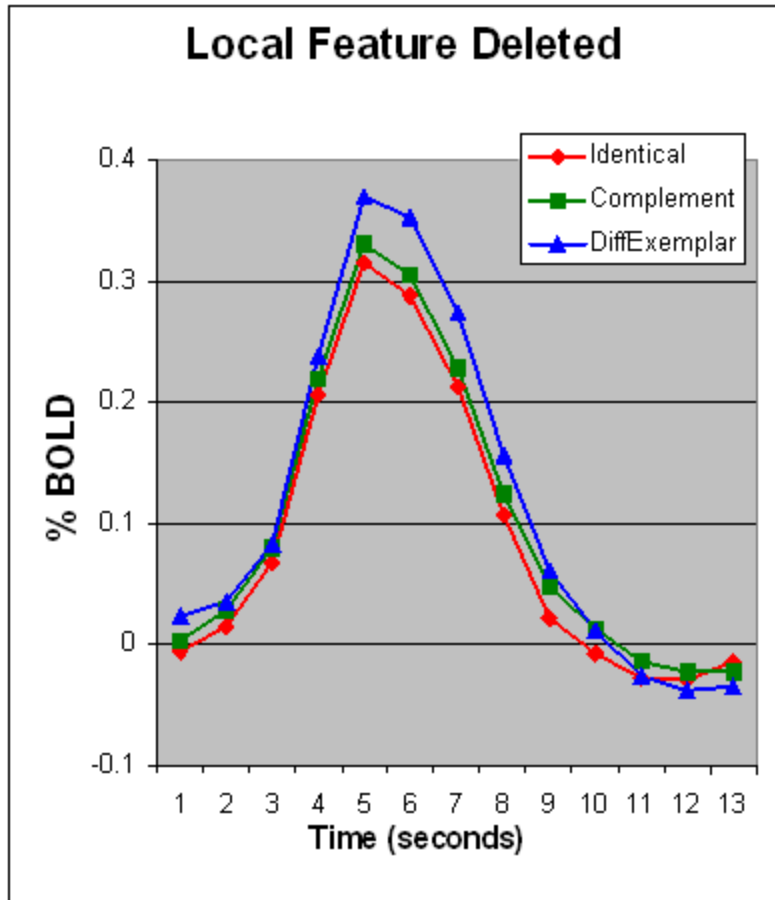

Local Feature Deleted: Complement vs. DiffExemplar,  $p < .01$

Part Deleted: Complement vs. Identical,  $p < .01$ . Hayworth & Biedermann, 2006

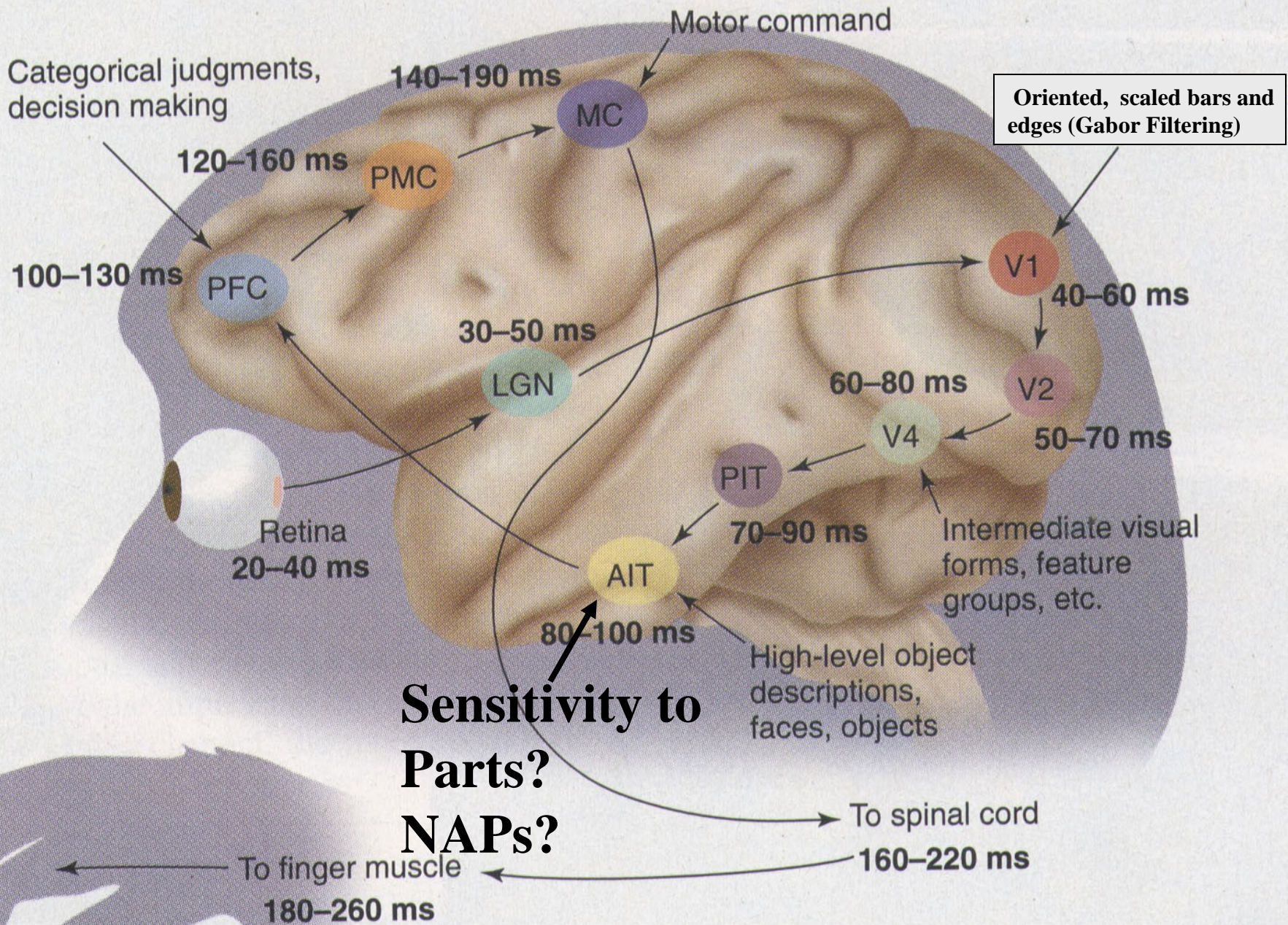

# K. Tanaka's reduction method:

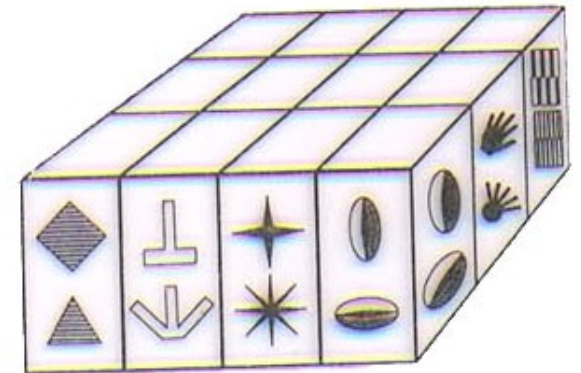
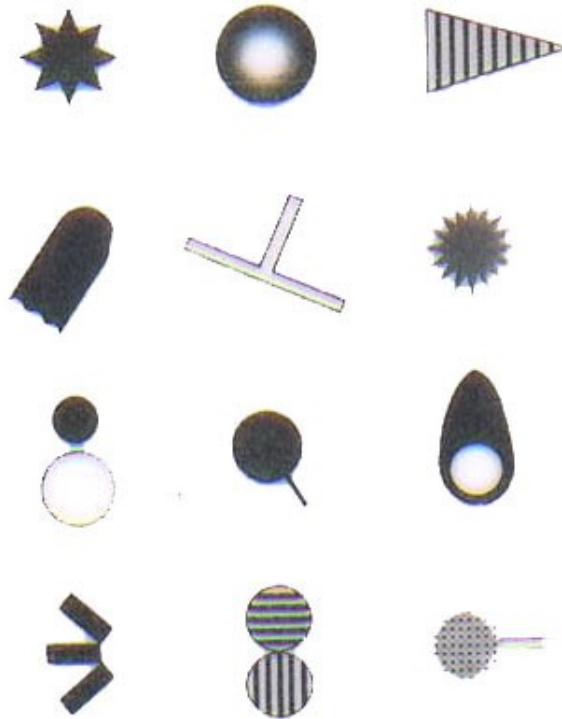
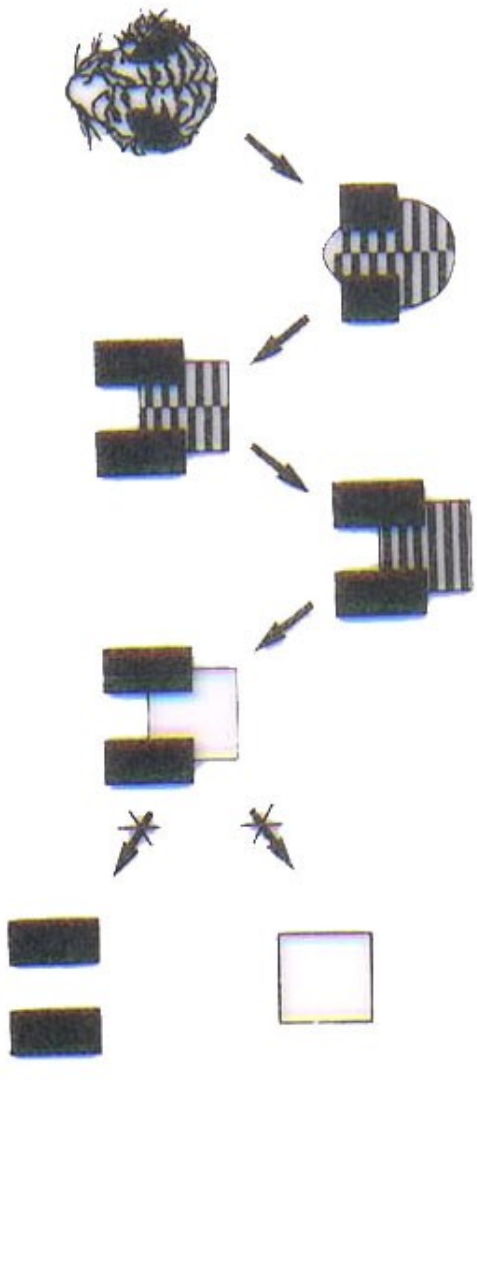

# A cell from K. Tanaka's lab:

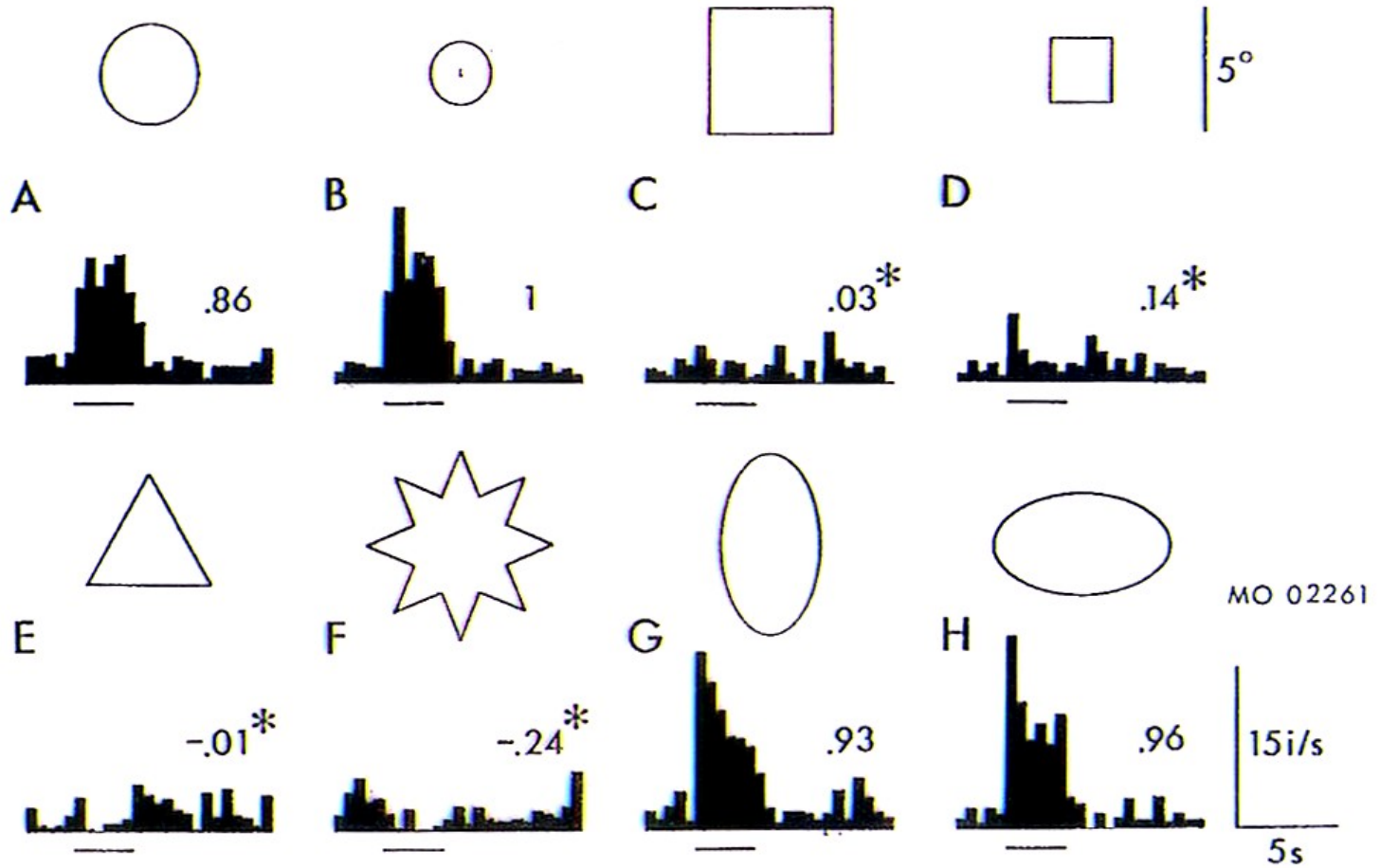



# Optical imaging by Tanifuji's group in Riken:

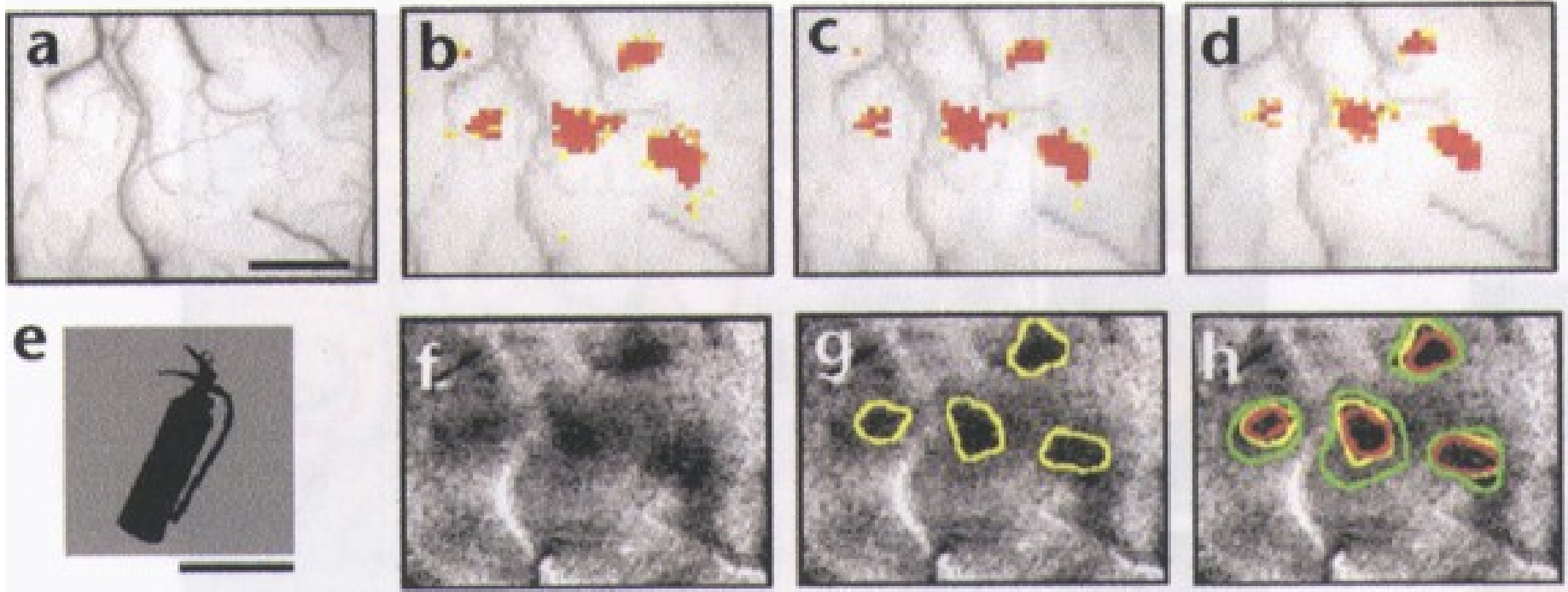

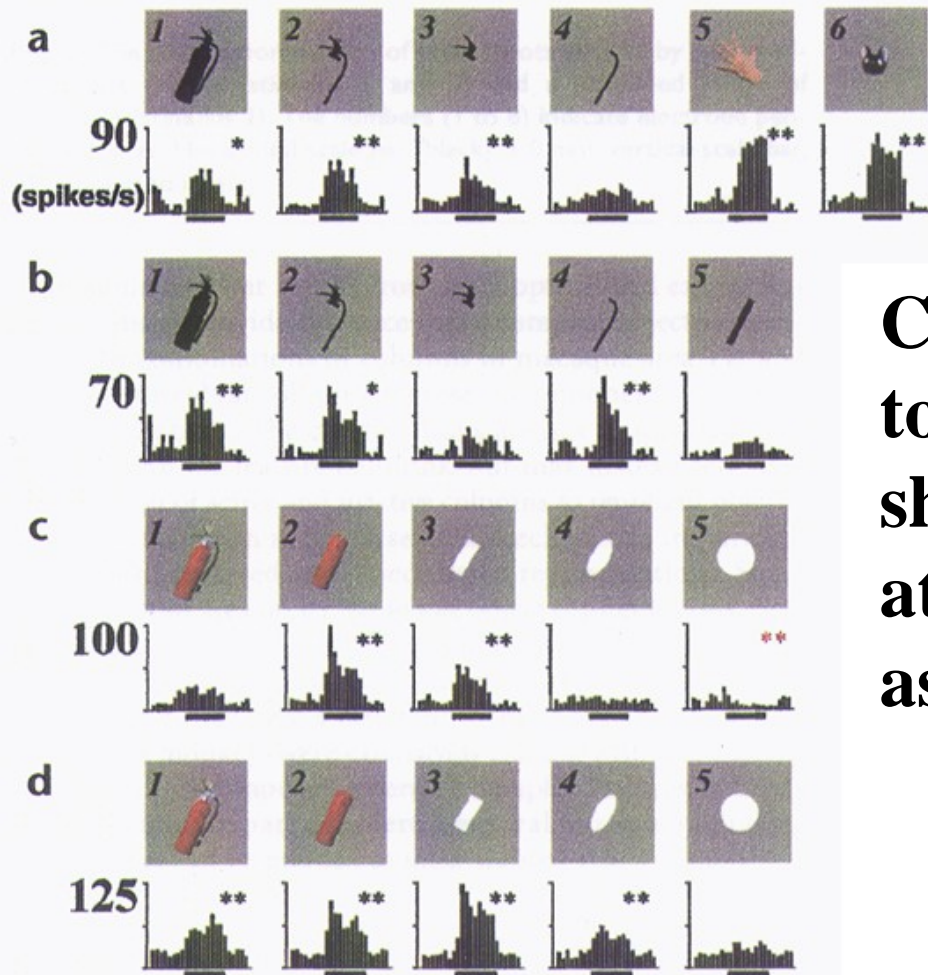

**Fig. 4.** Visual responsiveness of representative cells in spots A–D in Fig. 3d. (a–d) Responses in spots A (track 2; depth, 620  $\mu\text{m}$ ), B (track 3; depth, 540  $\mu\text{m}$ ), C (track 8; depth, 280  $\mu\text{m}$ ) and D (track 16; depth, 280  $\mu\text{m}$ ), respectively. Red asterisks indicate significant inhibition. \* $p < 0.05$ , \*\* $p < 0.01$ . Scale bars, one-second periods of stimulation.

**Cells in each spot seem to respond to a given shape or simple shape attribute, such as aspect ratio.**

# NAP versus Metric Properties

- **Non-Accidental Property (NAP) Differences** -- unaffected by rotations in depth (e.g. straight versus curved; vertex type (e.g. L vs. arrow)).
- **Metric Properties (MP)** - continuously affected by rotation in depth (e.g. angle of attachment; degree of curvature; aspect ratio).
- NAPs distinguish different kinds of object parts (geons) and allow recognition of objects at novel orientations in depth

# Nonaccidental vs. Metric Comparisons

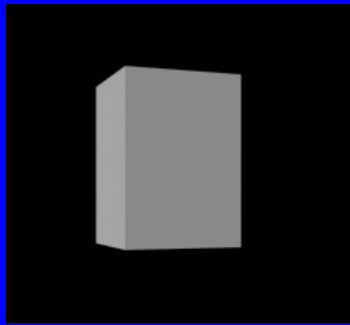

## Nonaccidental

Expansion versus no expansion of the cross-section

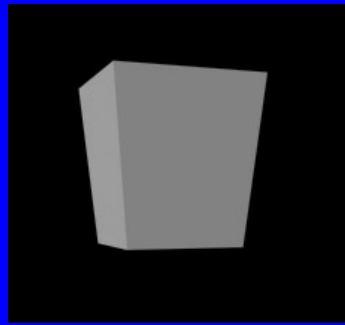

## Metric

Amount of expansion of the cross-section

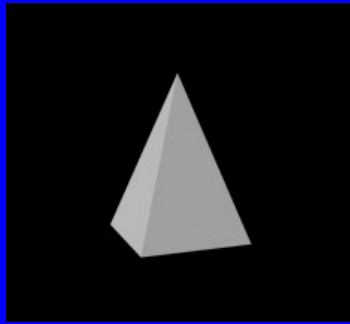
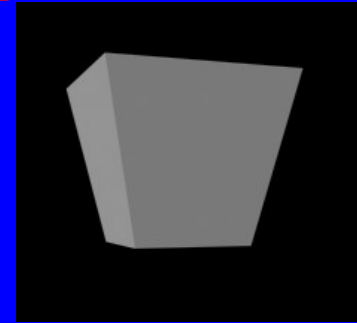

Negative curvature of the sides versus straight sides

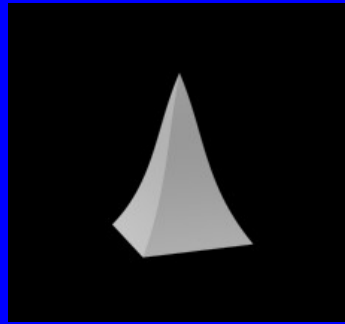

Amount of negative curvature of the sides

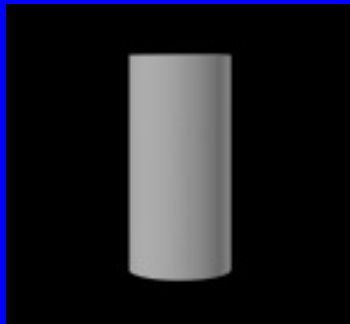
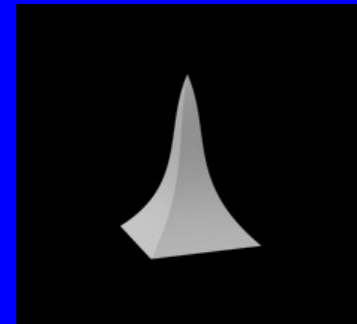

Positive curvature of the sides versus straight sides

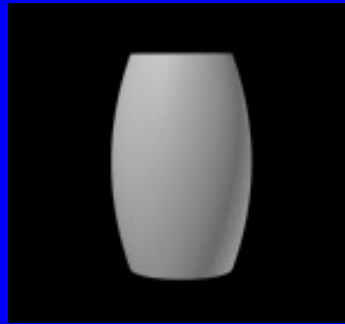

Amount of positive curvature of the sides

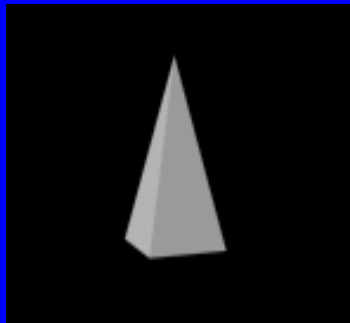
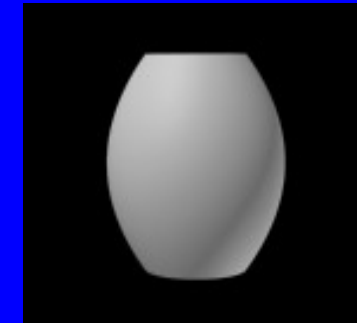

Curved main axis versus straight main axis

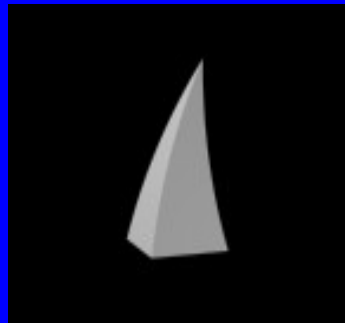

Degree of curvature of the main axis

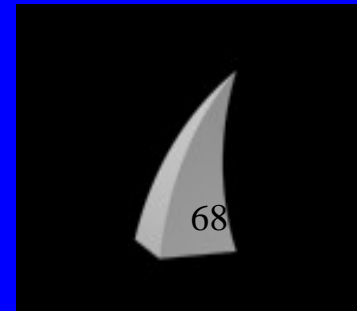

**A change in a nonaccidental property results in greater modulation than a change in a metric property. MP and NAP differences equated according to pixel energies.**

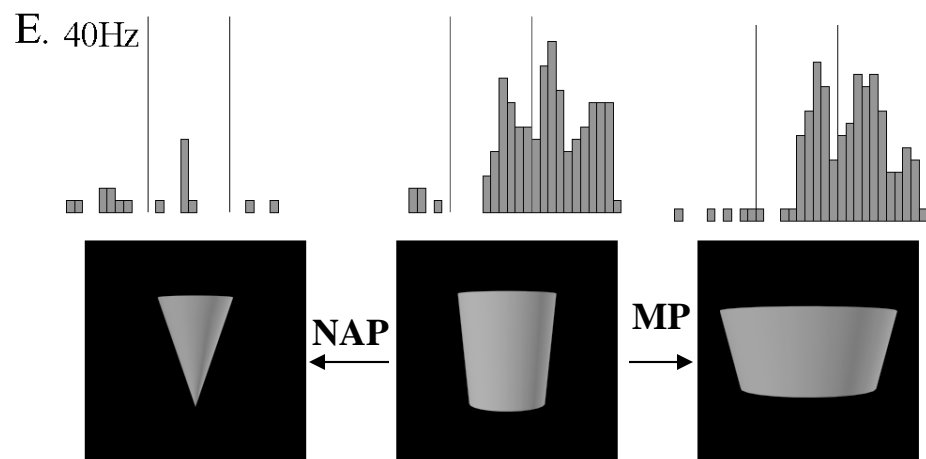
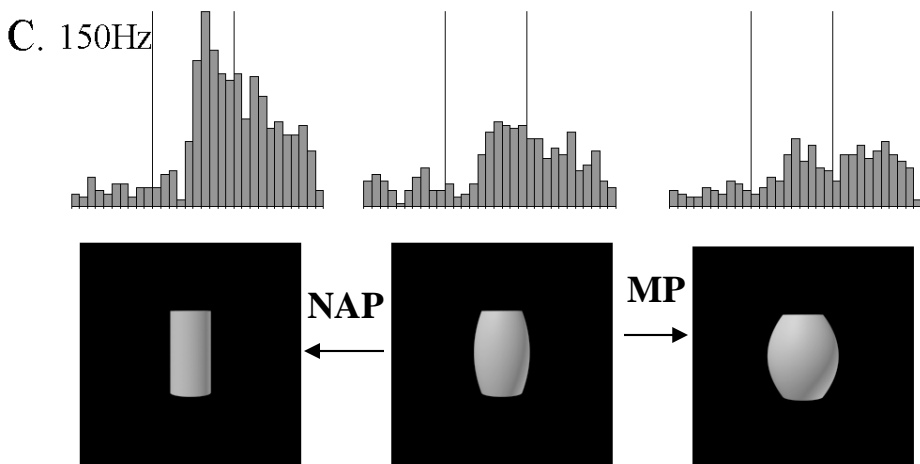
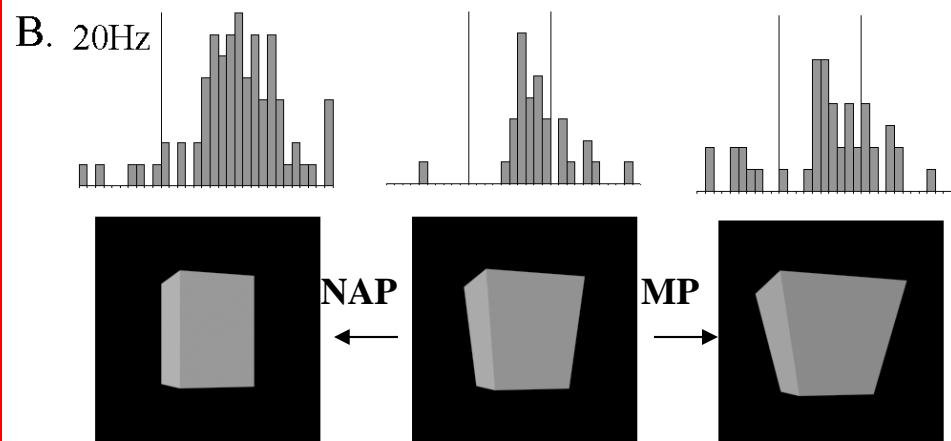
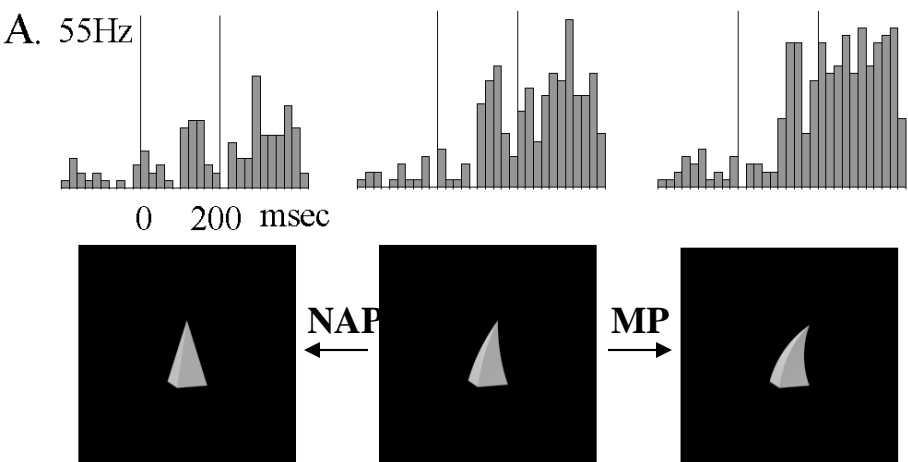

Differences in MPs have to be more than twice as large as NAP differences to produce the same magnitude of neural modulation (change, up or down, in spike rates).

Also,  
systematic  
effect  
of metric  
differences.

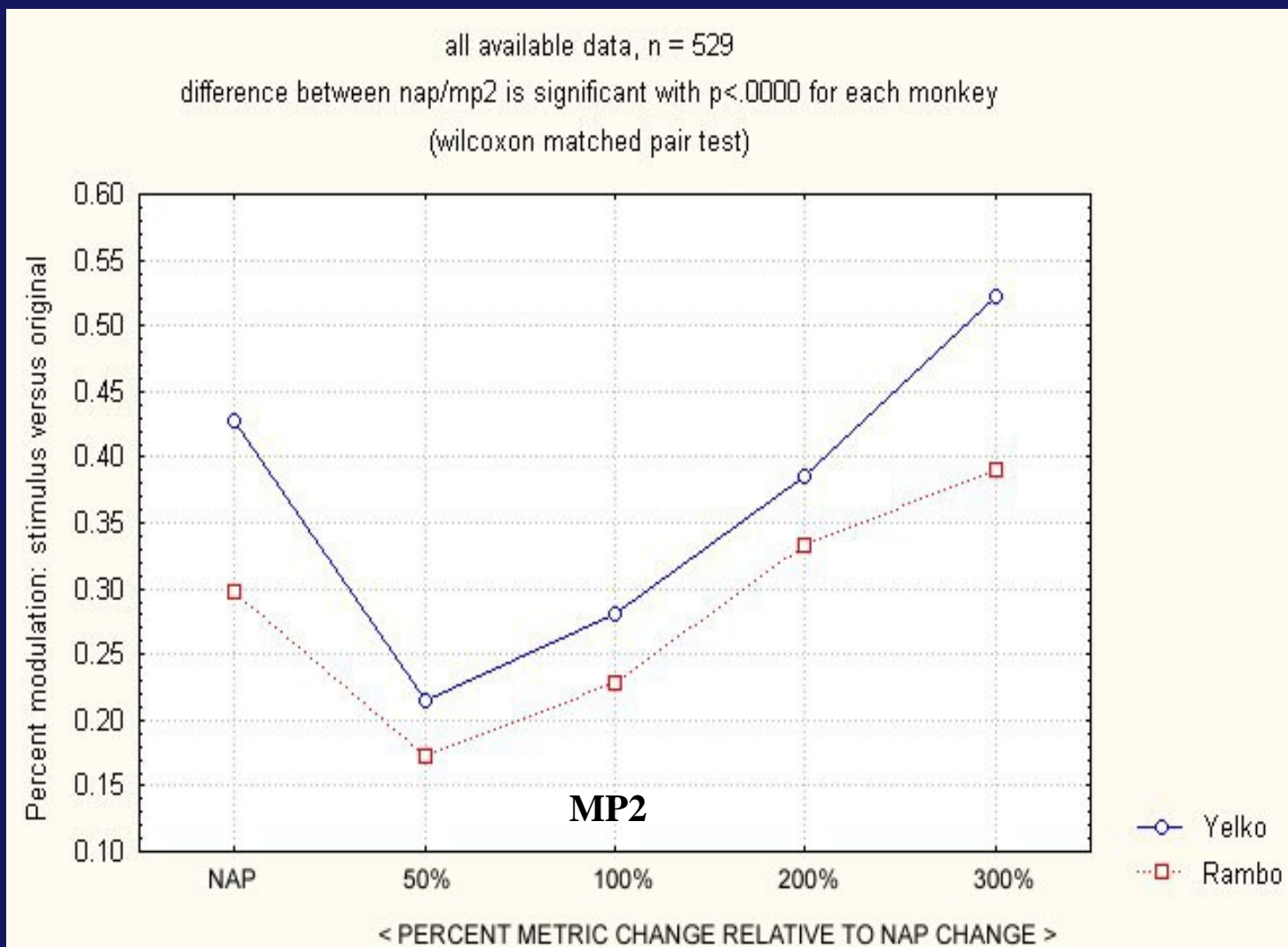

**The simple regular parts (horns, hooves, eyes) that can be represented as geons are well depicted in Paleolithic Cave art but metric variations (e.g., aspect ratio of bodies) or texture (e.g., of antlers) are not.**



**Oryx**



**Sable**

**Note good depiction of hooves and horns and relations among parts but only rough approximation to the body aspect ratio (a metric property).**







# Discrimination *among*

## NAPs of Regular Shapes (Easy) Irregular Shapes (Difficult)



**VS.**



**VS.**



## Discrimination of Regular *from* Irregular Shapes (Easy)



**VS.**



## Representation of the Relations Between Parts

**SM: 21 yr. old male who suffered a left occipital-temporal lesion**

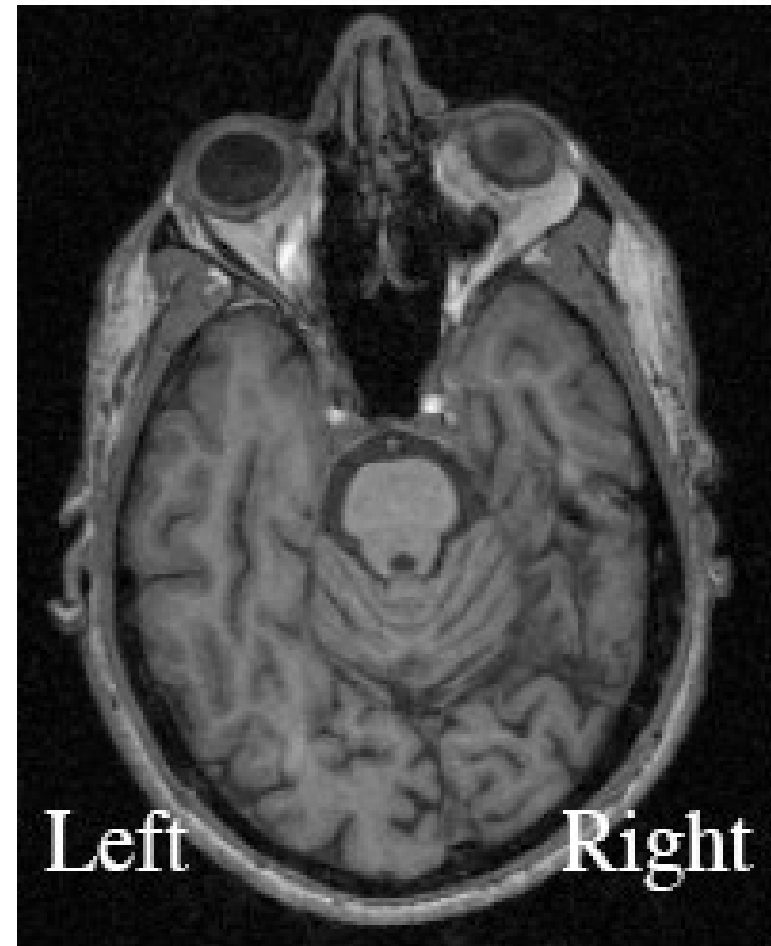

## A. Targets

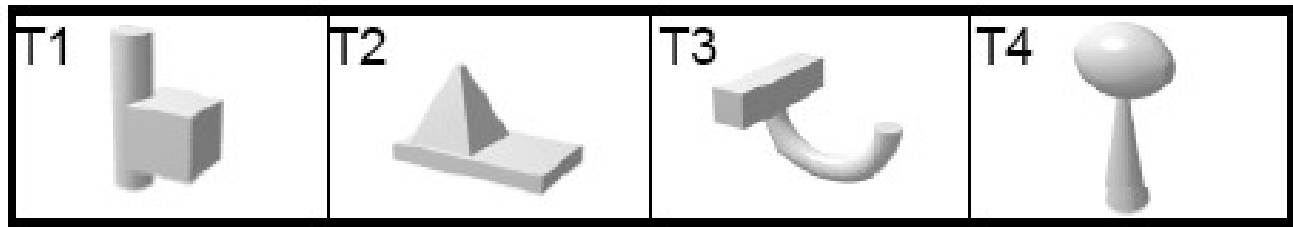

## B. Part- changed distractors

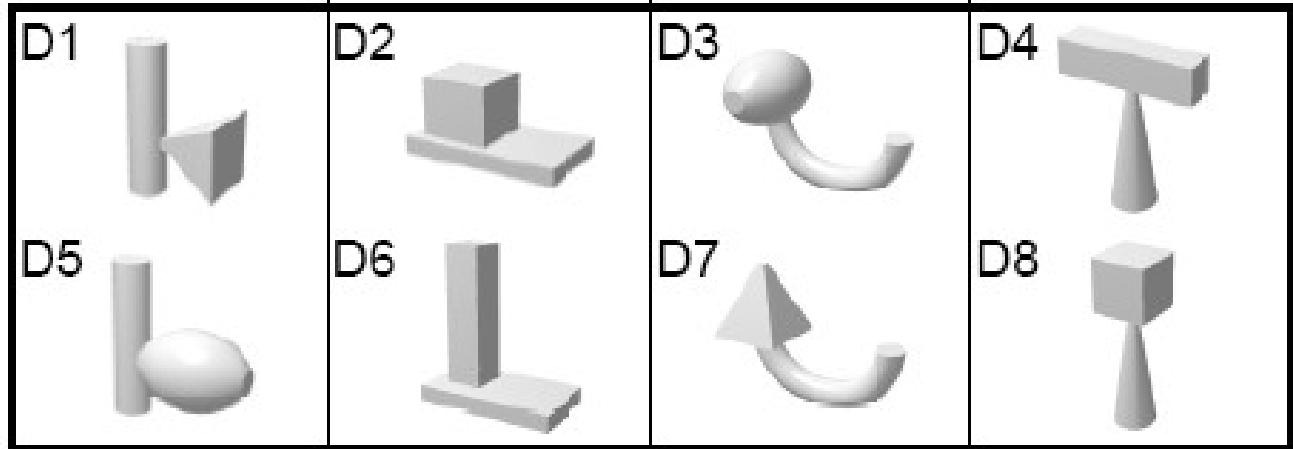

## C. Relation- changed distractors

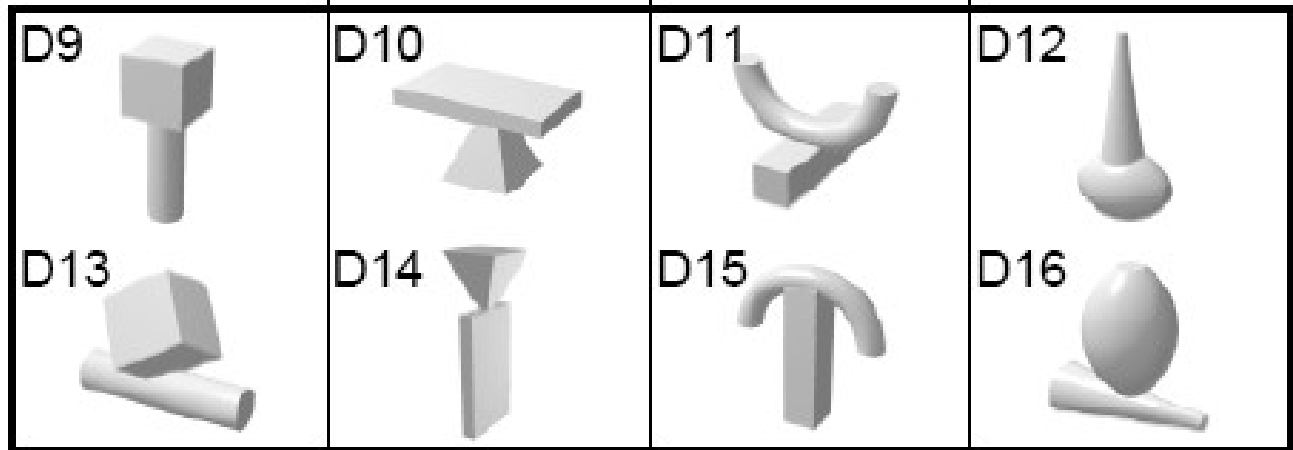

**SM can distinguish the part changed distractors (T1 vs. D1) from the targets but not the relation-changed distractors (T1 vs. D9)**

**Three sets of three different geons were each arranged with different relations between the parts to produce three different medial axis structures (Lescroart & Biederman, 2011)**

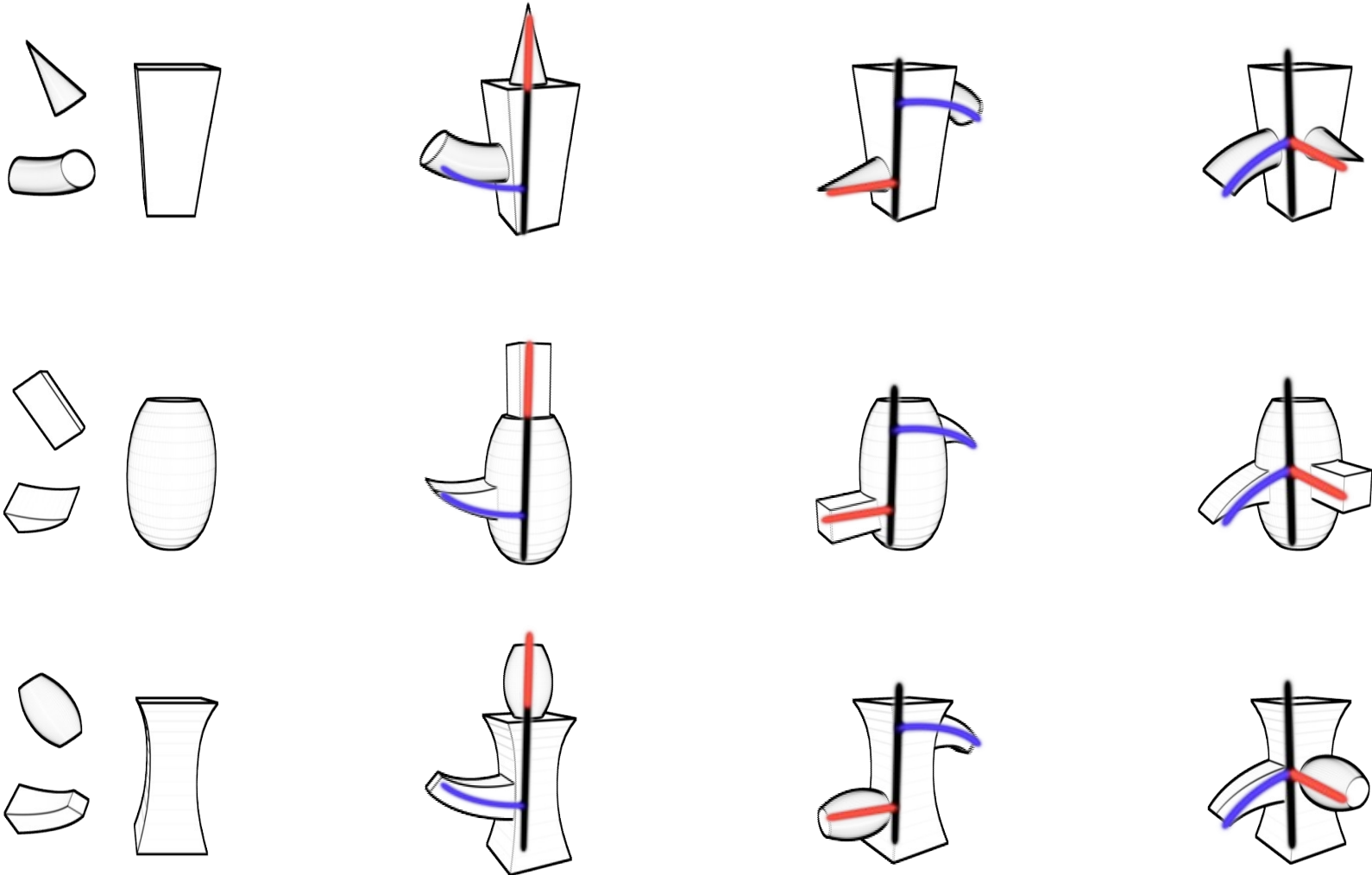

The nine objects were rendered in six different views each, for a total of 54 images

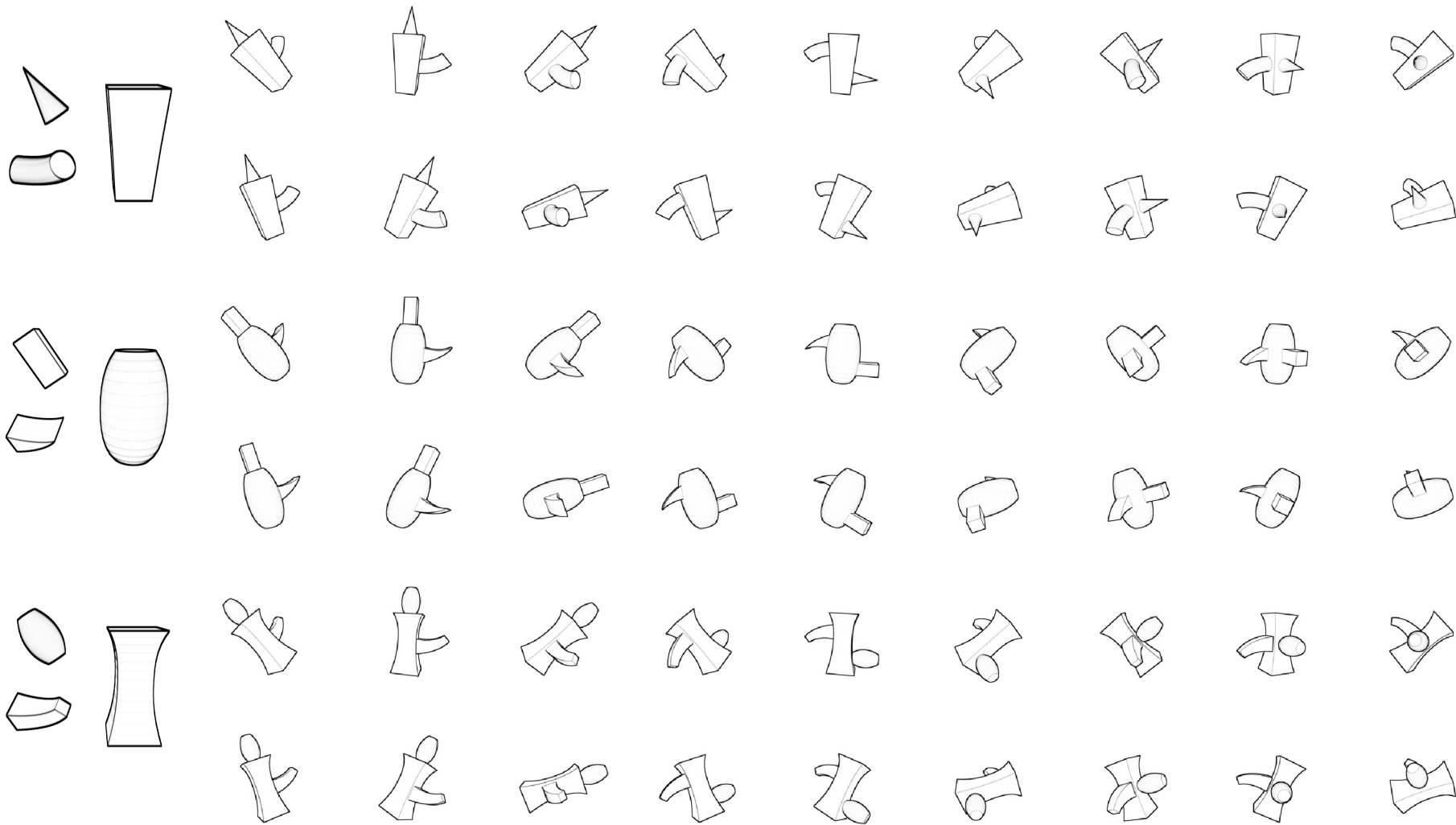

The stimulus set could be divided into groups in three different ways, according to different shared properties among the stimuli

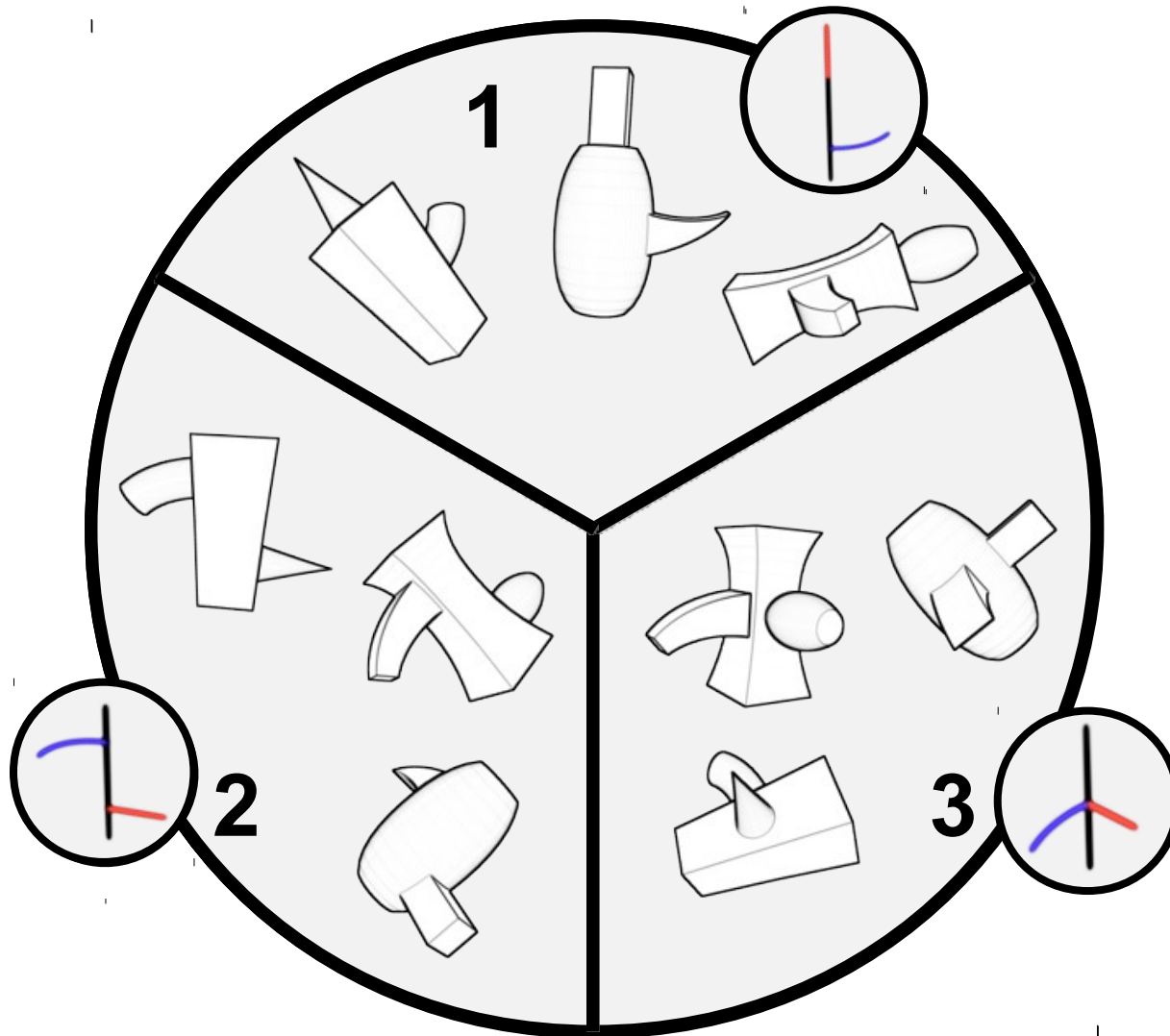

The stimulus set could be divided into groups in three different ways, according to different shared properties among the stimuli

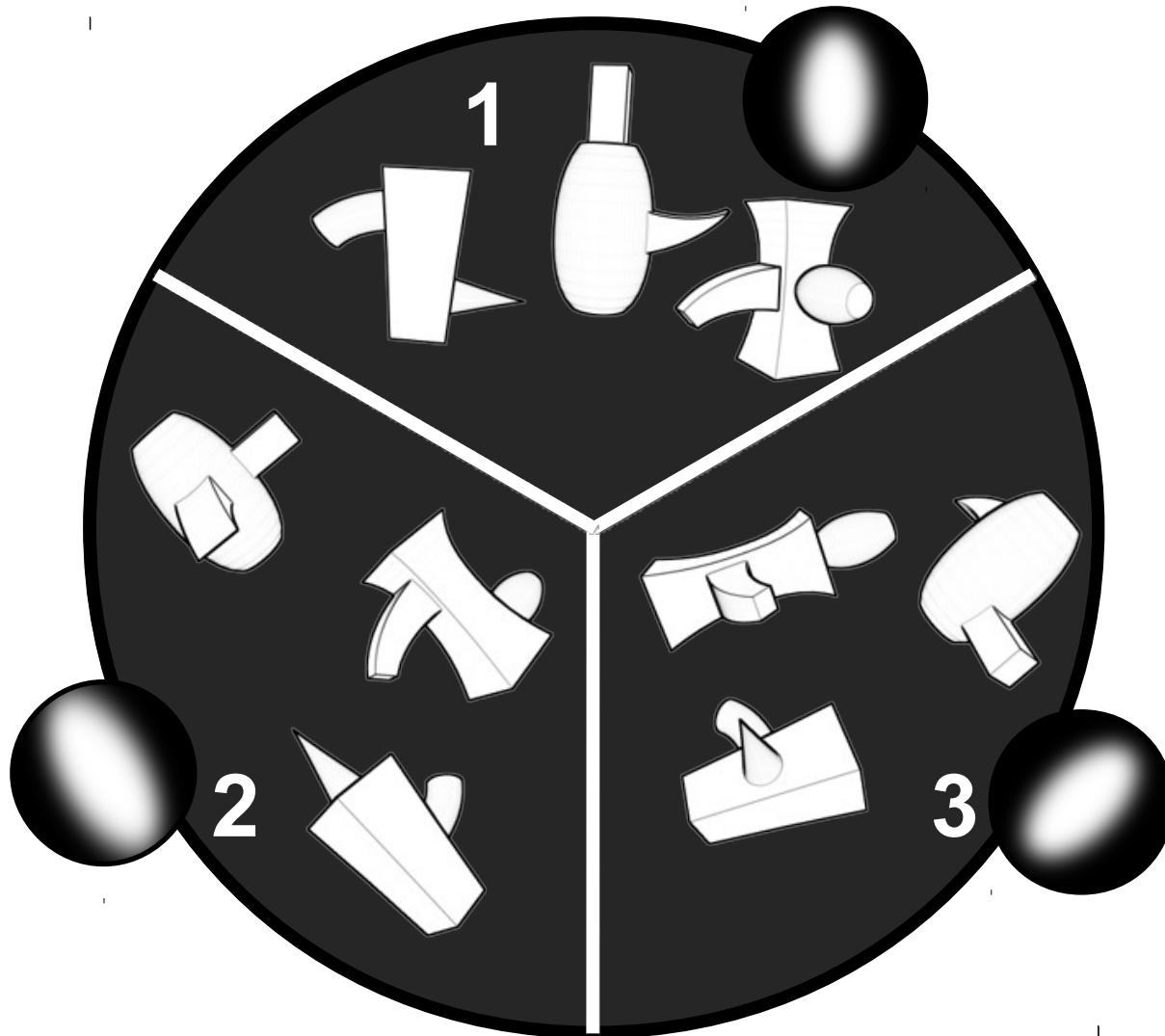



The stimulus set could be divided into groups in three different ways, according to different shared properties among the stimuli

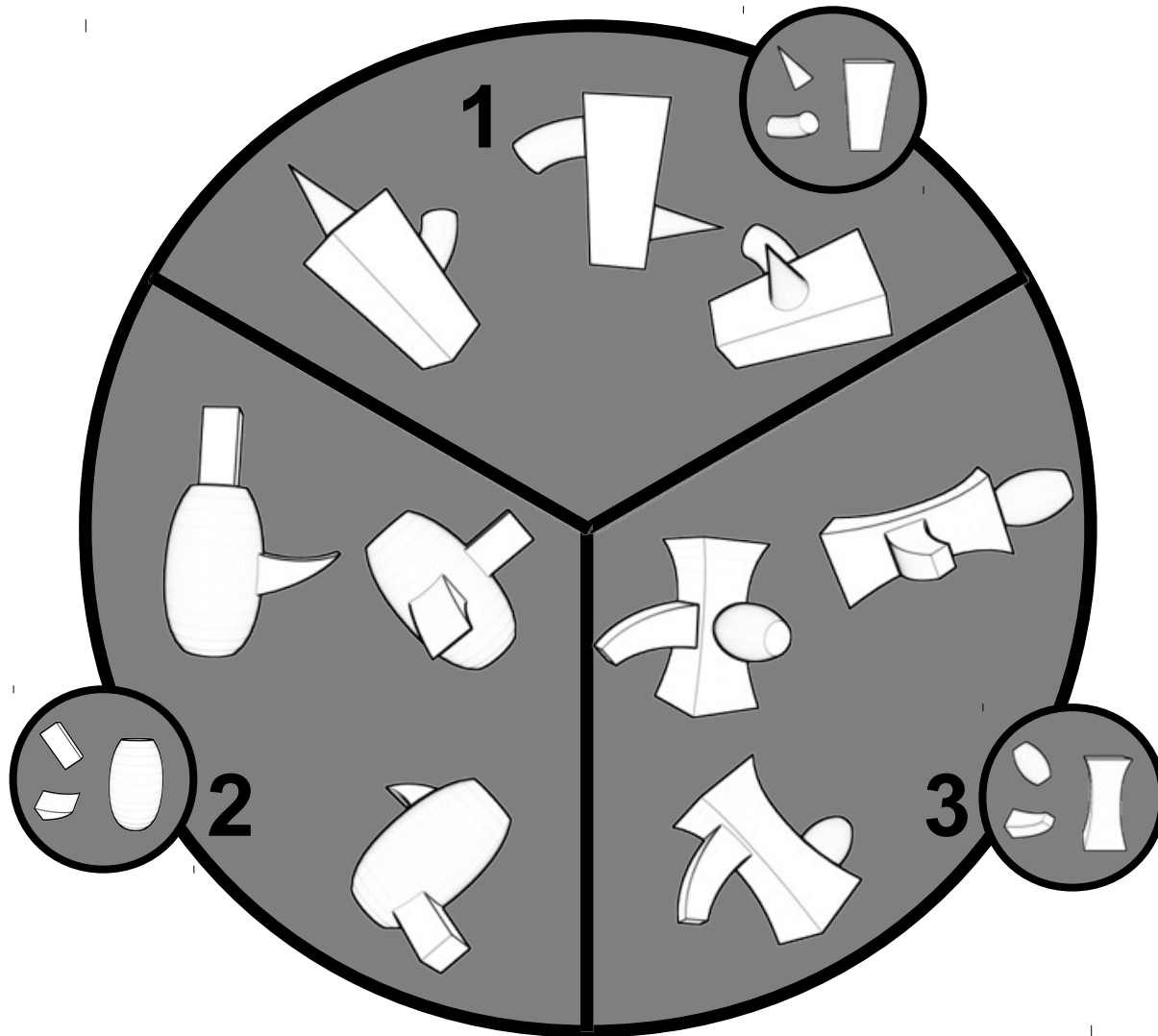

From V3 on, classification accuracy is greater for axis structure than for body orientation

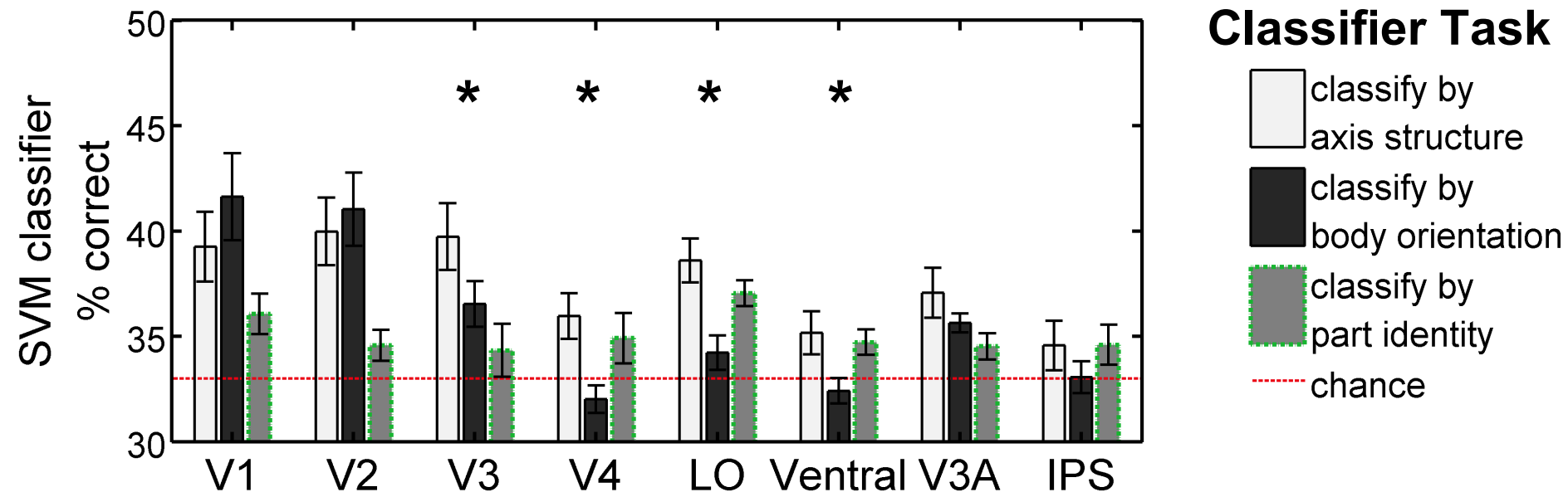

### Classifier Task

- classify by axis structure
- classify by body orientation
- classify by part identity
- chance

n=8 subjects

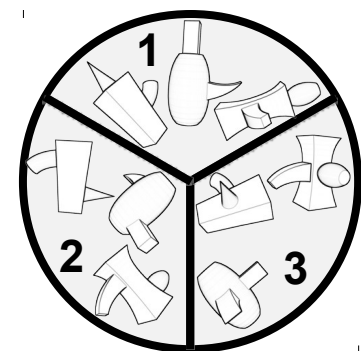

Classify by axis structure



Classify by body orientation

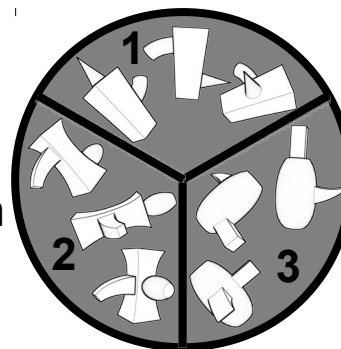

Classify by part identity

# Conclusion

**The representation mediating fast biological object recognition can be characterized as an arrangement of parts based on a nonaccidental classification of orientation and depth discontinuities.**

# Subordinate Object Categorizations

Two pure cases (ignoring faces, which are a special case):

1. **Availability of distinguishing *nonaccidental* (i.e., viewpoint invariant) differences**
2. **Necessary reliance on absolute (rather than comparative) *metric* (i.e., viewpoint dependent) information. Is this the 3.5'' or 4.0'' length?**

# **Four Points About Fine-Grained Subordinate Categorization**

- 1. People avoid making absolute metric judgments (particularly when fine grained) whenever possible.**
- 2. When classification performance is fast and accurate, a distinctive nonaccidental feature has been discovered**
- 3. When people must make metric judgments, their discriminative performance is almost perfectly predictable from a wavelet model of V1 simple cell filtering**
- 4. In the real world (i.e., outside of the psychophysics lab or certain rare industrial tasks) almost always nonaccidental distinctive features can be found to facilitate classification performance.**

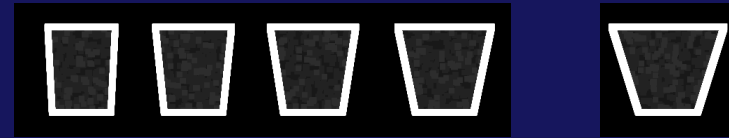

Tapering



Axis Curvature

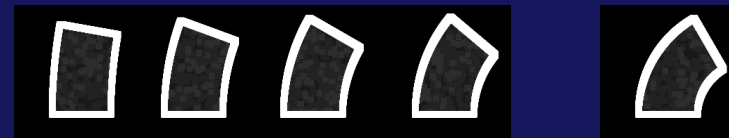

Axis Curvature



Pos. Curv. of the sides

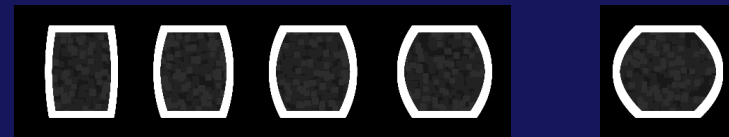

Pos. Curv. of the sides



Neg. Curv. of the sides



Neg. Curv. of the sides

# Sample Neuron ( $r^2 = 0.98$ )

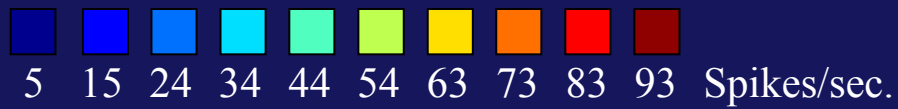

# Example Neuron ( $r^2 = 0.97$ )

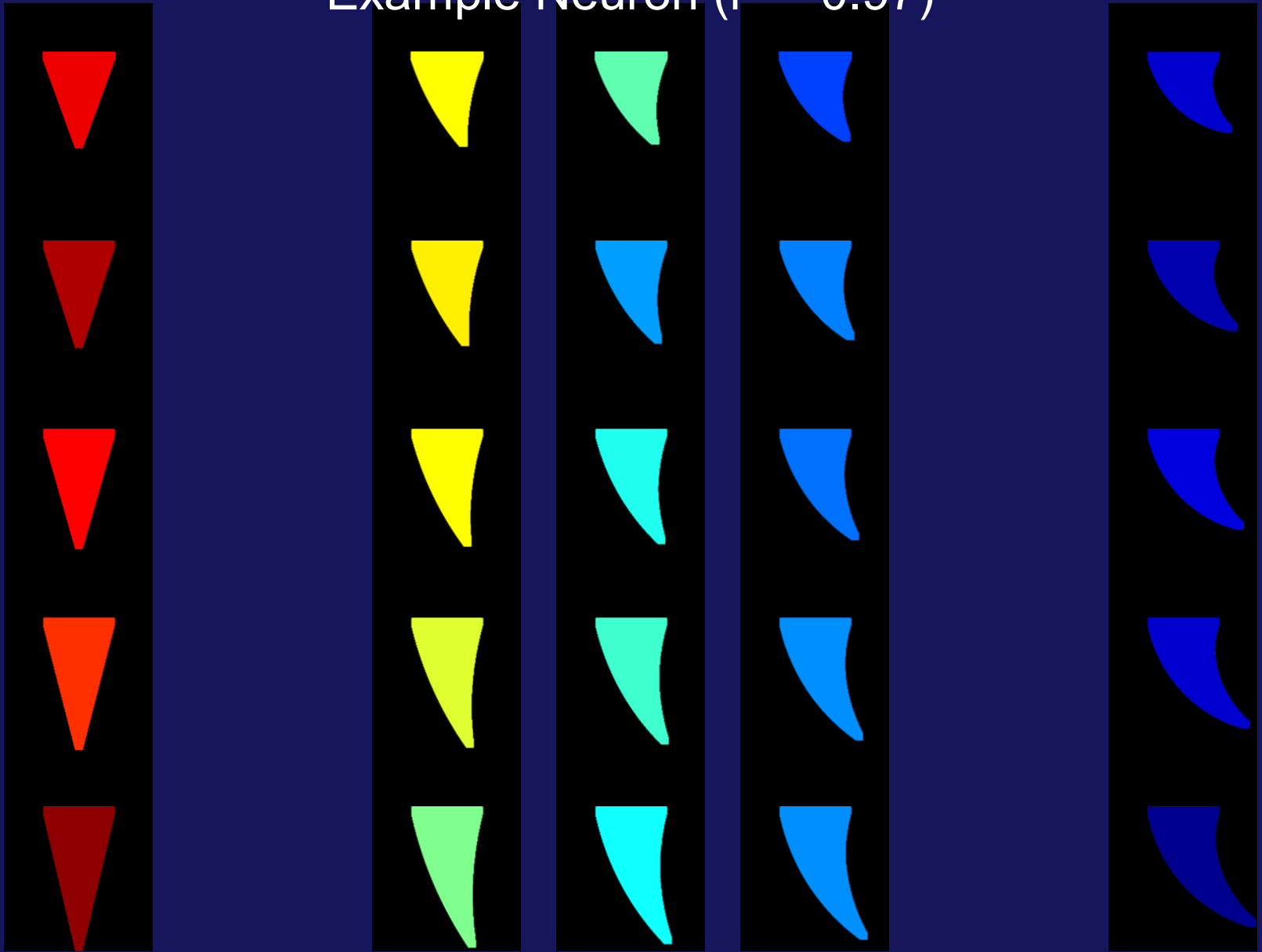

5 8 11 14 17 19 22 25 28 31 Spikes/sec.



2-dimensional projections of a  
4-dimensional MDS-solution of  
the Neural Euclidean Distances  
between the rectangles  
( $N = 98$ , sensitive neurons)  
 $R^2 = 0.99$

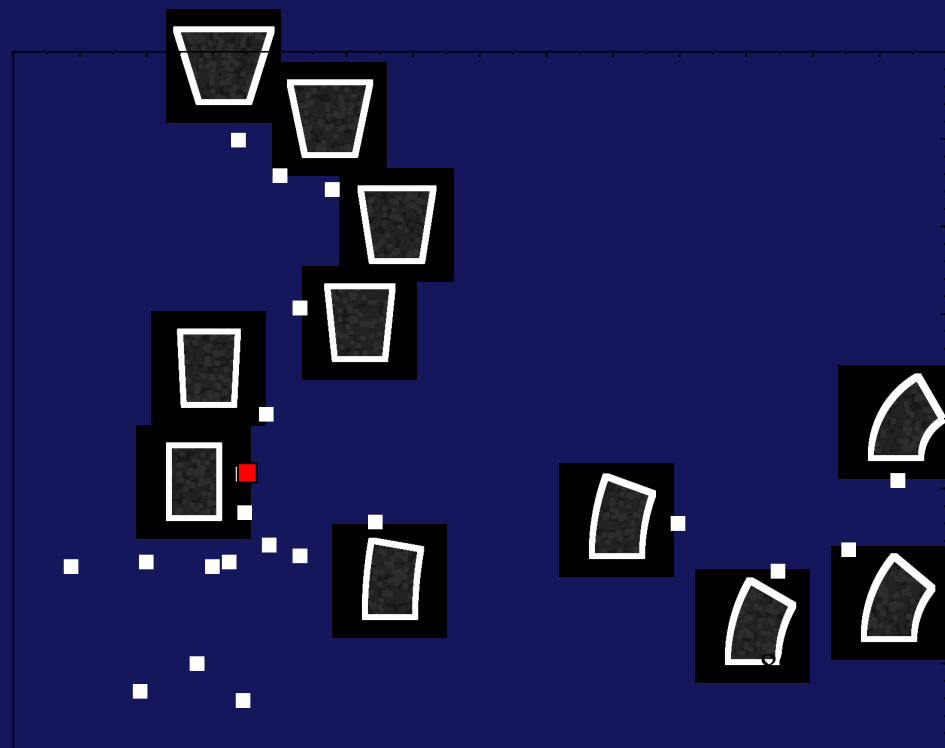
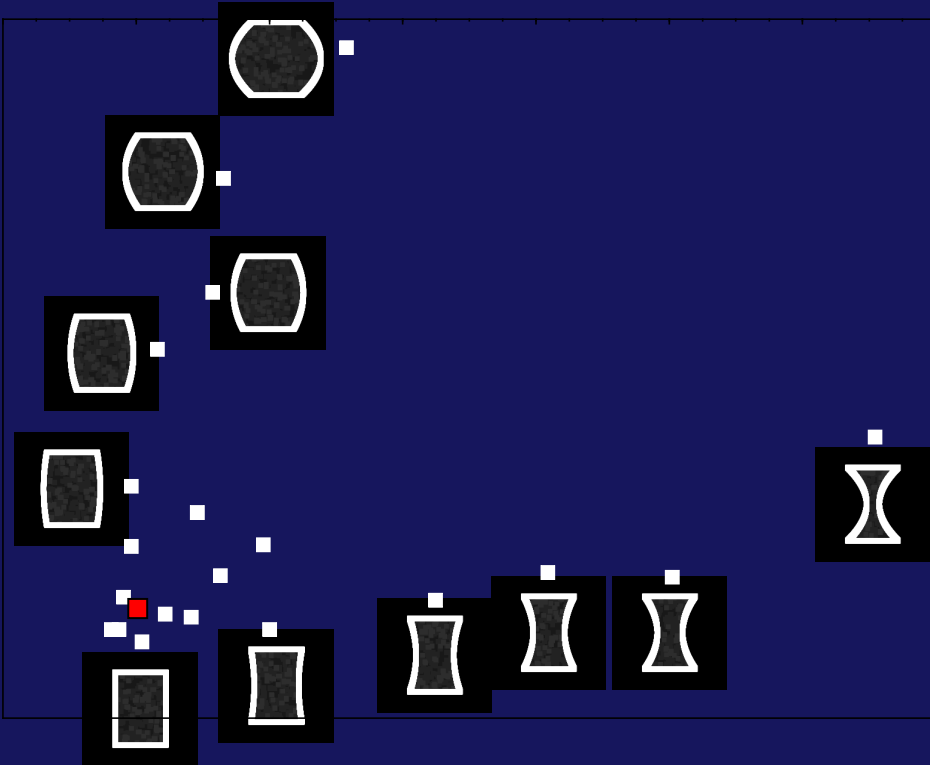

# Artist Rachel Whiteread's Collage of Her Son's Preferred Playthings



L.A. Times, 7 February 2010

# Subordinate-Level Classification: A case study

## Distinguishing similar birds (Western North American Male Quails)

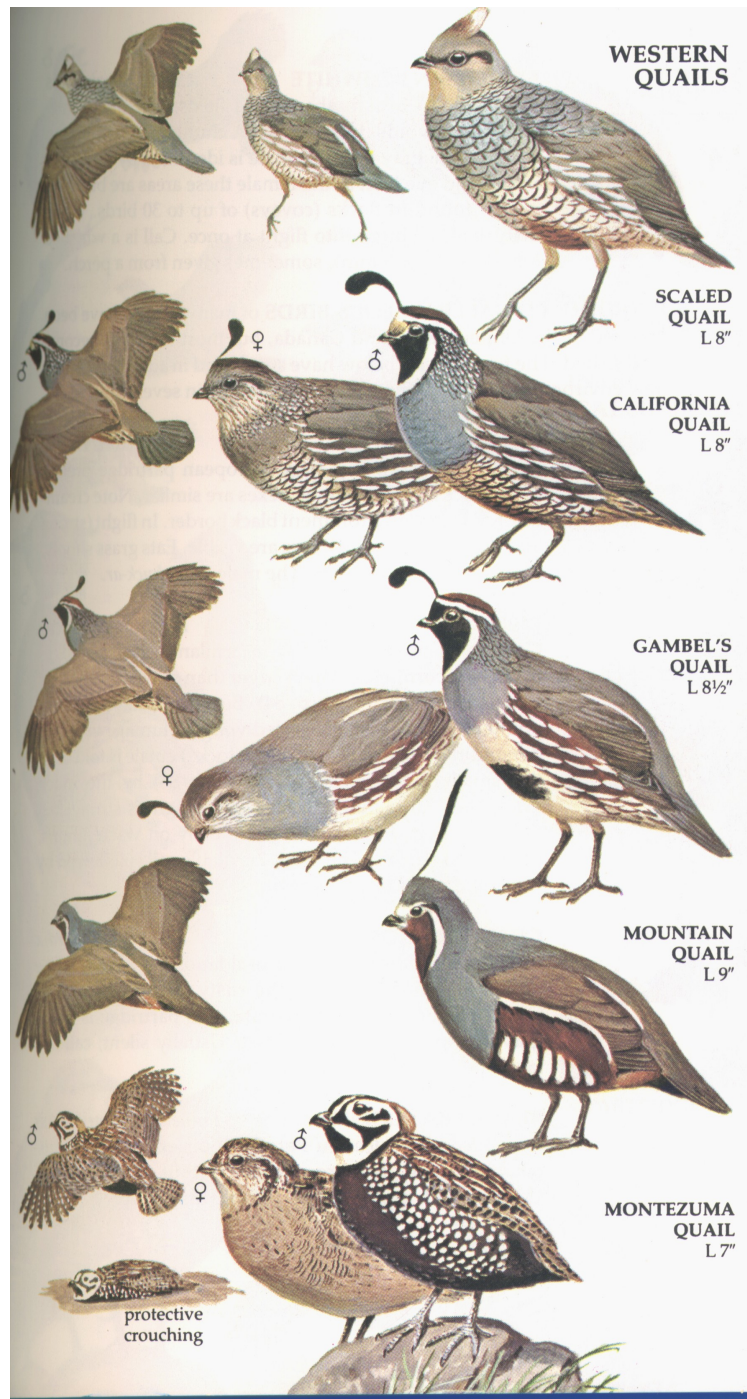

**You are on the phone with your friend who has these five birds in a cage and she wants to know their names (designated by number). What do you tell her so she can know which bird is which number?**

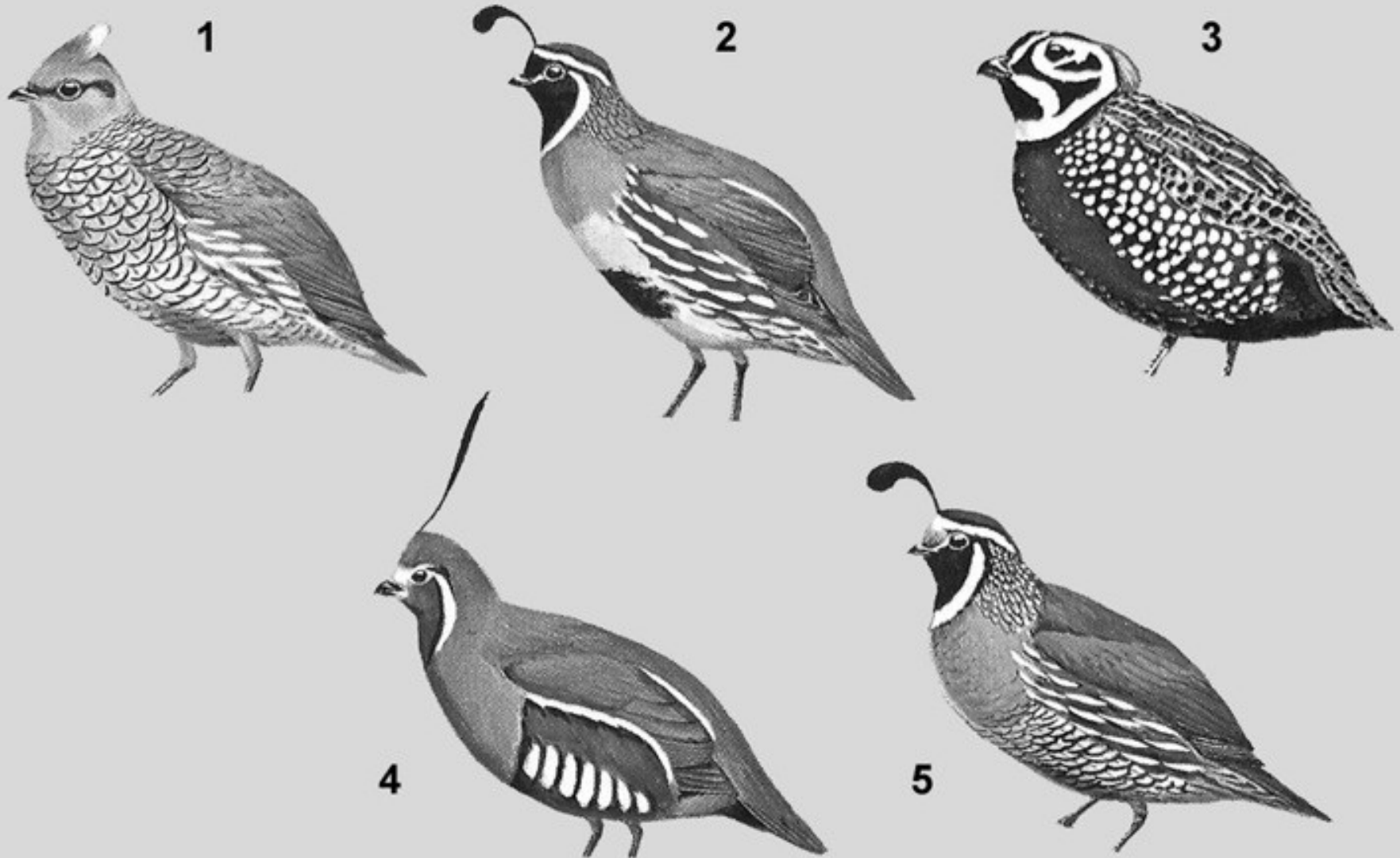

## #2 (Gambel's Quail)

*You* might have said:

“curved head feather” (distinguishes 2 and 5 from the others) and...

“black belly patch”

What does the Bird Guide say?

“teardrop topknot”

“black belly patch”

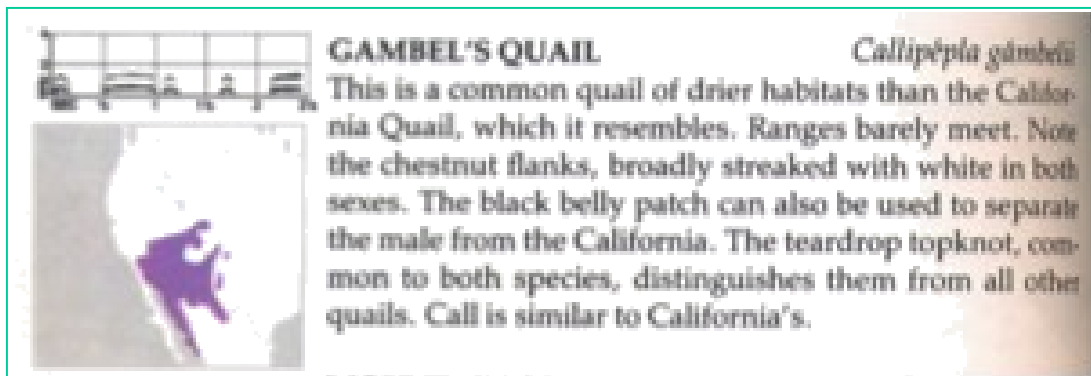

# DISTINGUISHING WESTERN U.S. QUAILS

- A. Curved teardrop topknot and a dark belly patch
- B. Long thin straight head plume; vertical white stripes on flanks.
- C. Curved teardrop topknot without a dark belly patch.
- D. Harlequin face.
- E. Cottony white crest.

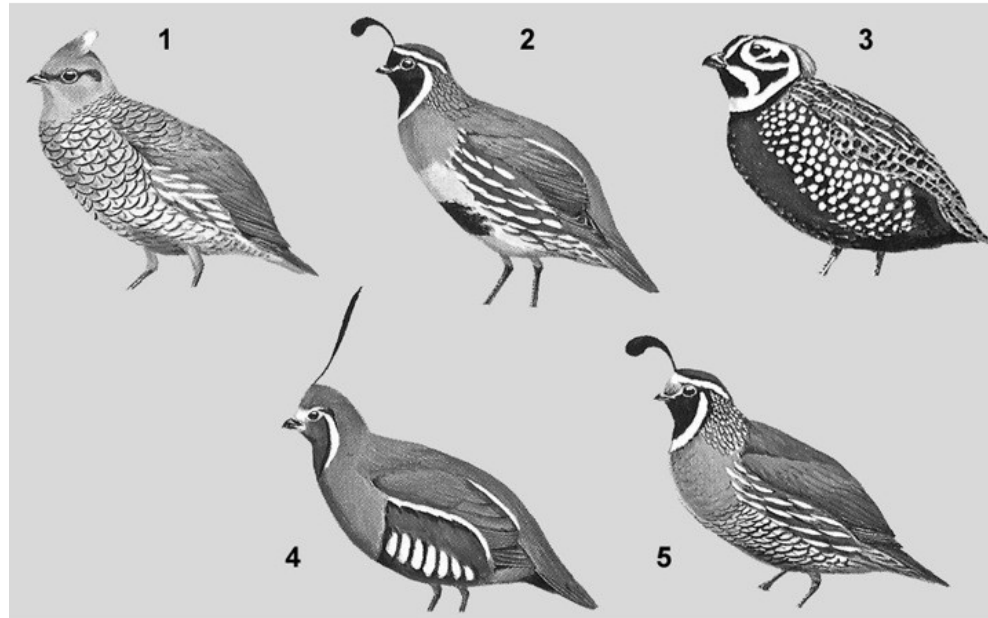

**Almost all the descriptors were nonaccidental and other novices could select the correct bird with high accuracy from these descriptors. (The experimenters were 100% with serious descriptors)**

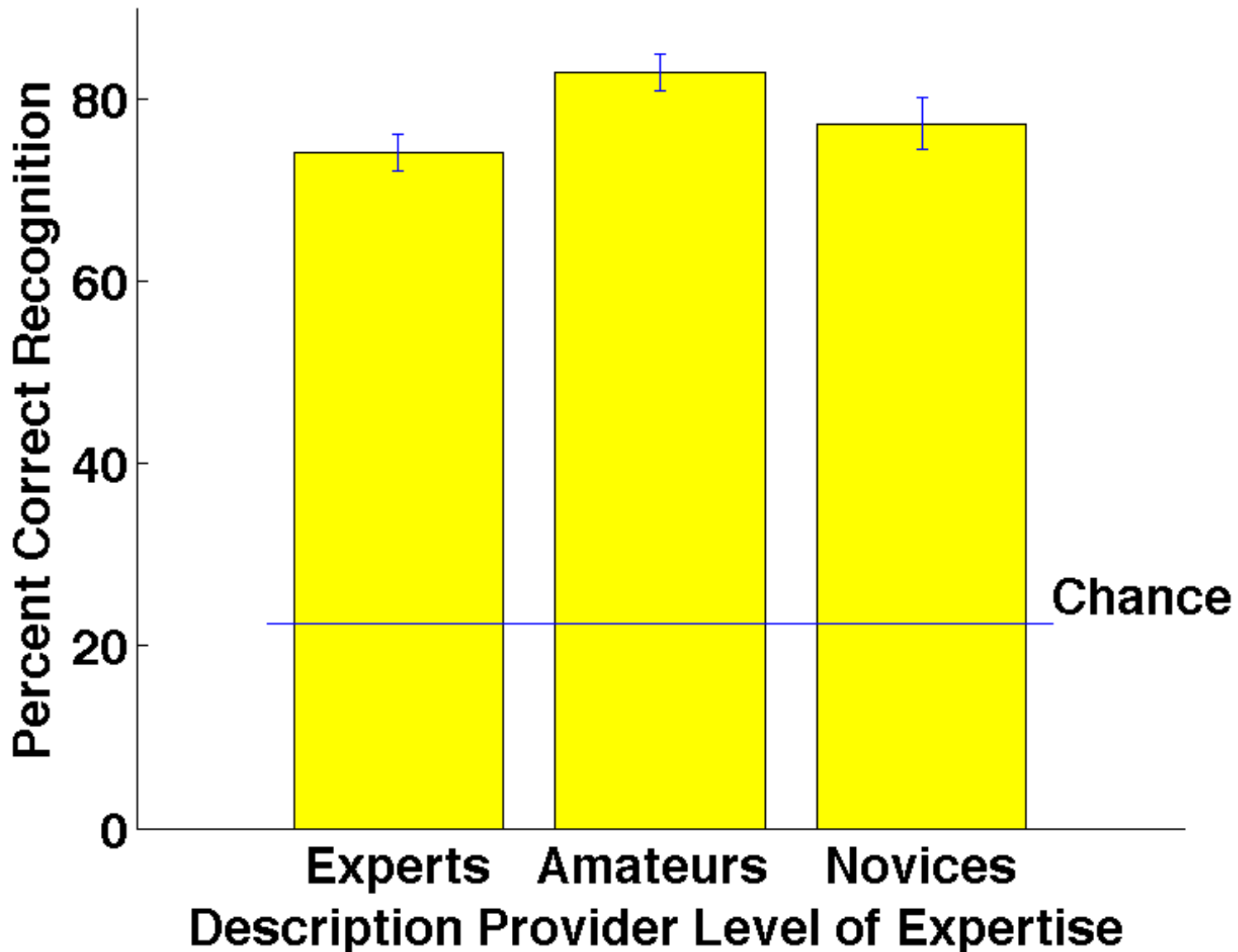

# Sexing day-old chicks: The most difficult visual discrimination task ever studied.

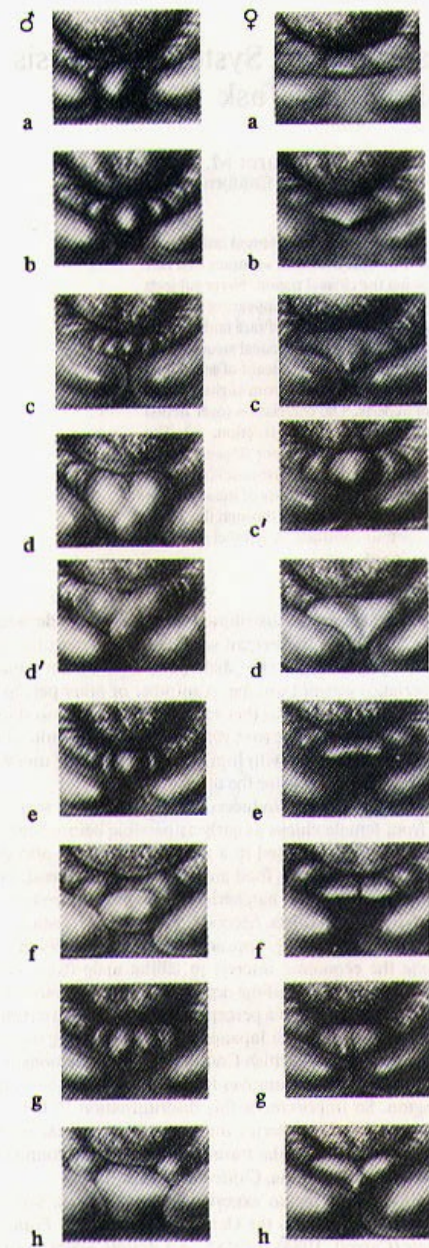

*Figure 1. Genital eminences of day-old chicks. (From "Sex Determination of Day-Old Chicks II: Type Variations" by T. H. Canfield, 1941, *Poultry Science*, 20, pp. 327-328. Copyright 1941 by the Poultry Science Association, Inc. Reprinted by permission. Male genitals are in the left column, female genitals in the right column.)*



# A Lifetime Spent Looking at Chicks

BY JERRY CARROLL  
CHRONICLE CORRESPONDENT

Davis  
Yolo County

**H**eimer Carlson has looked at 55,743,379 baby chickens in his life, picking them up and putting them down one at a time. This was not mere idle curiosity.

Carlson, who may have done this more times than anyone in the history of the human race, found out which of them was male and which female. In case you're interested, it was about even.

But now, after a half a century of inspecting chickens, he figures it is time to move on to other things. Carlson, 69, is retiring.

"I've enjoyed it," he said one day last week as sat on a stool at the University of California campus here and worked his way through another box of newly hatched chicks not long from the incubator.

Working at a rate of about 800 chicks an hour, Carlson lifted each downy chick from a peeping mass, deftly twirled it in his hand, turned it bottom side up, and took a gander at it through a magnifying lenses attached to his spectacles.

The unaided eye is unable to make out what Carlson looks for — an "eminence" the male chick has and the female doesn't in the vent Carlson's thumbnails expertly reveal — but he identifies the gender of the birds correctly something better than 99 percent of the time.

"Concentration is the important thing," he said. The males went into a box at his left and the females in a box to his right.

When Carlson first began "sexing" chickens (to give this process its proper name) in 1934, it was as revolutionary to the poultry indus-

try as the computer chip was to communications.

Up to that point, poultrymen had to wait six or seven weeks to discover which birds were cocks and which pullets. Their interest was more than academic.

Pullets lay eggs and produce profit, while cocks strut around eating their heads off. When they're not doing that, they're crowing at dawn or beating up on one another to establish dominance. During those weeks before gender could be determined and the males culled from the flock, a lot of expensive feed disappeared down those profitless gullets.

**T**hen, as now, the Japanese were on the cutting edge. "They were the first to learn how to tell the sex of a chicken," Carlson recalled. Rumors of this great and wondrous skill reached Petaluma, then the Egg Basket of the World.

"It was the depth of the Depression," said Carlson. "I graduated from Petaluma High School in 1933. I stayed on the family ranch for about a year, not getting anywhere. Then, in 1934, my agricultural teacher dropped by one day."

His news was that the Japanese secret had been learned, and that the hatcheries were sponsoring a chicken sexing school in Petaluma to teach the technique. Carlson was among the first 25 men to enroll in the four-month course.

The palm went to the young and the swift. The older students found their eyesight wasn't keen enough to pick out the eminences, nor their thumbs supple enough to reveal the vents before the fragile young chicks croaked in numbers unacceptable to the growers.

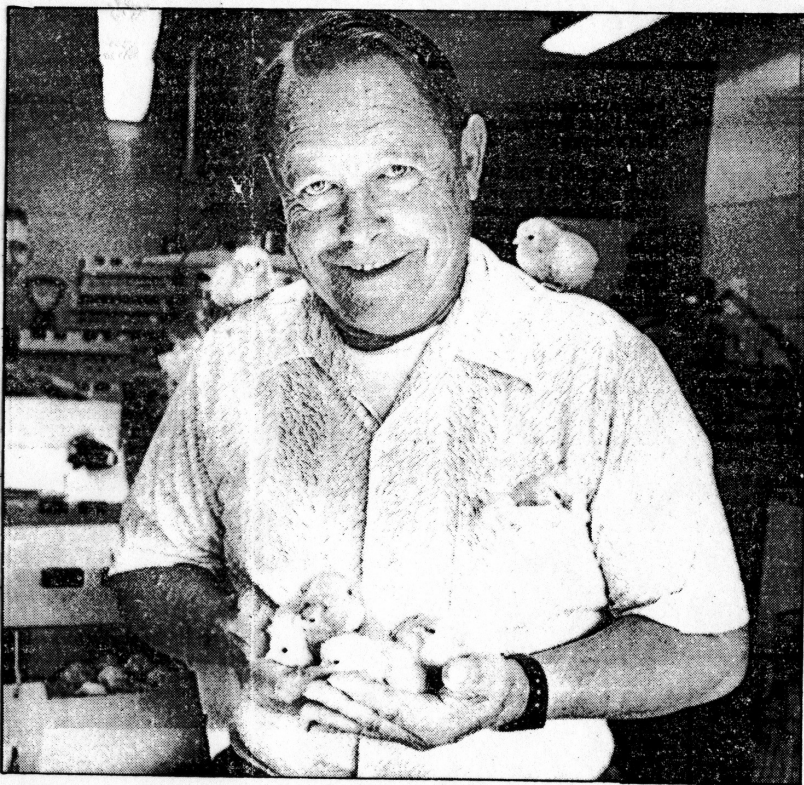

PHOTOS BY BRANT WARD

Heimer Carlson (above) and the little guys (above and below) who've been his bread and butter for 50 years. Certainly, they're not ALL guys — but only Carlson knows for sure

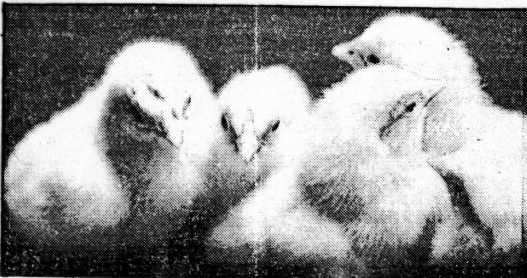

sexers being paid a half a cent for each chick inspected.

That may not sound like much, but it mounted up when Carlson hit his stride. He could routinely inspect 10,000 chicks a day. It was great money for the Depression. His skill was deemed crucial to the war effort and he was exempted from military service.

**B**ecause he was working at a piece rate, he kept records. Carlson can tell you exactly how many chickens he inspected the day World War II began and ended, when Roger Maris broke Babe Ruth's home run record, the day of the first moon walk, when the Beatles first played together, when polio vaccine was discovered — or any other occasion you care to name.

This is all recorded in 50 pocket-size notebooks filled with such notations as "H&N (a hatchery) — 1500." Carlson hit his peak in 1949 when, working 12 hours a day and more and sometimes seven days a week, he inspected 1,926,365 chickens. His second best year was 1951, when he looked at 1,751,050.

In 35 of the last 50 years, his totals topped a million. Last year he looked at 275,534 chicks, receiving two cents for every one inspected.

"You have to have a certain temperament to do this hour after hour," said Jean, his wife of 43 years. "You have to be calm and on an even keel."

Science has tried to simplify the chicken sexing process. At one point, it came up with a tiny tube attached to an eyepiece the inspector was supposed to look through. It took too much time, though, and was discarded.

But the geneticists have been more successful. Now they are producing breeds of chickens in which the sexes can be identified by color, wing feathers or combs. It's been a long time since Carlson knew of any sexing schools being held. So maybe his is a dying trade.

But it's been good to him. "I don't know what else I would have done for a living," he said.

"You hold them too long and you lose them," Carlson said.

He passed with flying colors in the test conducted by a professor from Berkeley who conducted autopsies on the chicks to verify the judgments of the students.

It was believed then that the closeness of the work would mean eventual blindness for the chicken sexer peering for a few years into all those tiny orifices.

"Lucky for me, my eyes have held up," Carlson said. Petaluma then had more than a score of hatcheries. Work at first was seasonal, with Carlson and the other

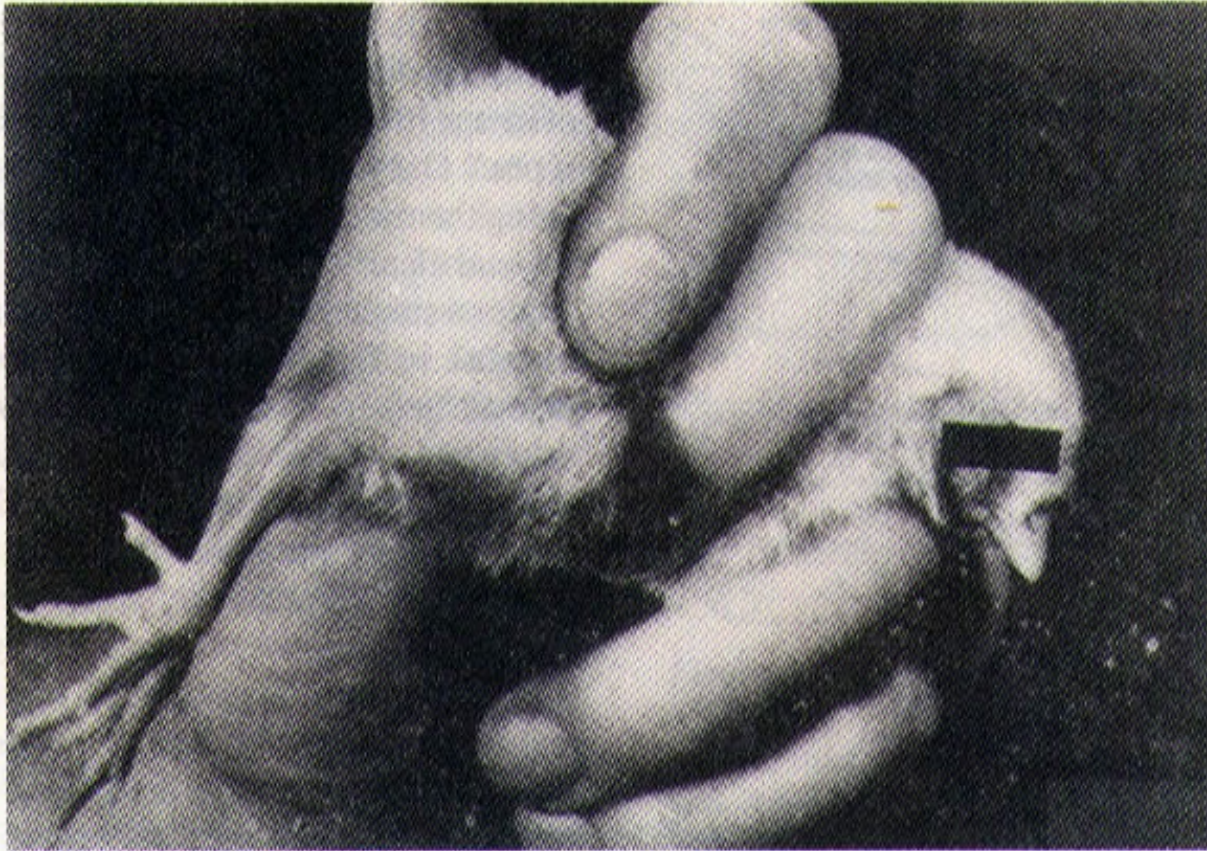
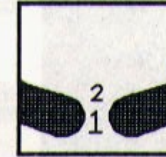

Figure 2. An accepted grasp for chick sexing. (Modified from "Chick Sexing" by J. H. Lunn, 1948, *American Scientist*, 36, pp. 280–287. Copyright 1948 by the *American Scientist*. Photograph by the University of Minnesota Photographic Laboratory. Adapted by permission.)

# Knowing where to look and what to look for

Now you will be asked to sex-type another set of chickens. You should use the following rules to discriminate between the male and female genitals. The first part of your task should be to locate the informative region. In order to find this point, you should look for the two large cylindrical side lobes near the bottom of each picture. The genitals are located either between the ends of these two lobes (1) or slightly above the ends (2).



After you have found this area, you should study the swellings present there. It is at this point that males may be differentiated from females. Male chicken genitals tend to look round and fullish like a ball or watermelon. Here are two examples:

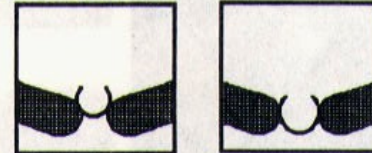

Female chicken genitals can take on two different appearances. They can look pointed, like an upside down pine tree, or flatish. Here are two examples:

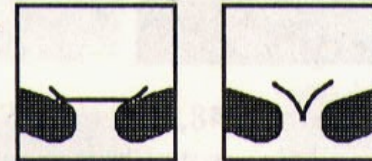

Usually, but not always, male genitalia are larger. Sometimes either sex will appear to have double genitalia. You should differentiate the following 18 pictures based on this set of rules. Again, nine of the pictures are male and nine female in random order. You should begin the task by studying all of the pictures carefully. If you decide that a pictured set of chicken genitals belongs to a male, circle the "M" after the corresponding number on your answer sheet. If you decide that the pictured genitals belong to a female chicken then circle the "F" after the corresponding number on your answer sheet. Please work carefully. Once you understand these rules, you may turn this paper over and begin. Any questions?

Figure 3. The experimental instructions for chick sexing.

After 60 sec of training (being told where to look and what to look for) naive subjects were as accurate as experts and missed the same pictures as the experts.

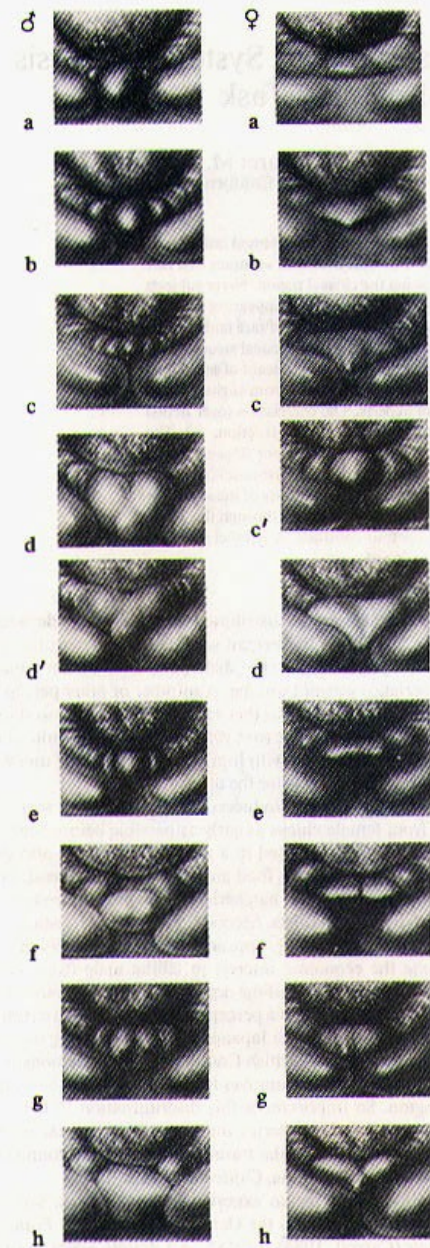
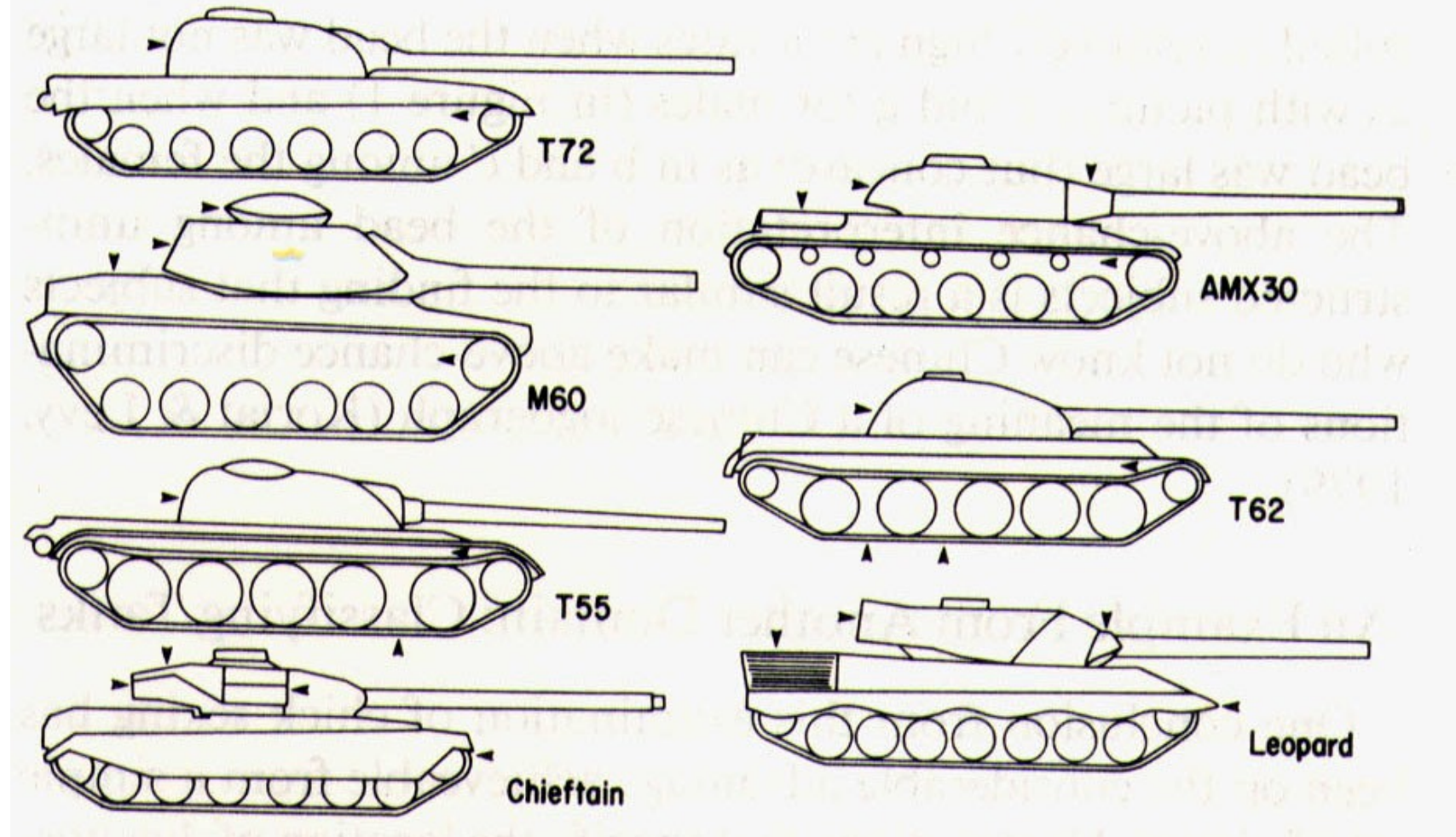

Figure 1. Genital eminences of day-old chicks. (From "Sex Determination of Day-Old Chicks II: Type Variations" by T. H. Canfield, 1941, *Poultry Science*, 20, pp. 327-328. Copyright 1941 by the Poultry Science Association, Inc. Reprinted by permission. Male genitals are in the left column, female genitals in the right column.)

# Distinguishing Russian from NATO tanks



If the rear of turret (*where to look*) is completely curved (*what to look for*) it is a **Russian tank**